

Catalogue of Approved Marine Safety Signs

Maritime Safety Queensland

This page has been intentionally left blank

Table of contents

Table of amendments2

Introduction3

REGULATORY SIGNS4

 MS1001 – MARINE SPEED LIMIT5

 MS1024 – MARINE SPEED LIMIT WITH REDUCE WASH7

 MS1002 – END MARINE SPEED LIMIT9

 MS1003 – SMOOTH WATERS SPEED LIMIT UNLESS SIGNED OTHERWISE10

 MS1004 – WATER SKIING PROHIBITED11

 MS1005 – WATER SKIING PROHIBITED – SPECIFIC CONDITON14

 MS1006 – WATER SKIING PROHIBITED – SPECIFIC CONDITIONS17

 MS1007 – OPERATIONAL SPEED LIMITS19

 MS1008 – MARINE SPEED LIMIT – SPECIFC CONDITIONS20

 MS1009 – SUPPLEMENTARY SIGNS28

 MS1025 – FREESTYLING PROHIBITED (WITH VARIABLE TEXT)37

 MS1026 – FREESTYLING PROHIBITED38

WARNING SIGNS39

 MS1010 – OVERHEAD POWERLINE40

 MS1011 – DANAGER OVERHEAD POWERLINE44

 MS1012 – BUSY WATERWAY NAVIGATE SAFELY46

 MS1013 – UNDERWATER PIPELINE DO NOT ANCHOR48

 MS1014 – POTENTIAL OBSTRUCTIONS – VARIALBE TEXT49

 MS1015 – UNDERWATER OBSTRUCTION50

 MS1016 – SHALLOW WATERWAY51

 MS1017 – POTENTIAL OBSTRUCTION52

 MS1018 – SHARP BEND53

 MS1019 – SAND BANKS54

 MS1020 – NARROW CHANNEL55

 MS1021 – END OF NAVIGABLE WATERS56

INFORMATION SIGNS57

 MS1022 – OPEN WATER AHEAD CHECK YOUR SAFETY EQUIPMENT58

 MS1023 – VESSEL MONITORING CAMERAS IN USE59

Table of amendments

If you have any questions regarding this document or if you have a suggestion for improvements, please contact:

Contact officer: Andy Bell, Senior Advisor, Aids to Navigation, Maritime Safety Queensland

Phone: +61 7 3066 3943

Date	Description	Version
March 2014	First issue	01

Introduction

The *Maritime Safety Queensland Act 2002* provides Maritime Safety Queensland with power to do anything necessary or convenient to be done for the performance of its functions. This includes the design of specialised marine safety signs for use on waterways.

The Catalogue of Approved Marine Safety Signs (the Catalogue) has been produced by the Maritime Services Section of Maritime Safety Queensland (MSQ), following consultation with all regional offices of MSQ.

The Catalogue contains marine safety signs to cover the management and regulation of the operations and activities of vessels on Queensland waters, consistent with all gazette notices published for speed limits and prohibitions, as at 1 January 2014.

The Catalogue only contains designs for marine safety signs approved for use in Queensland waters by the General Manager of Maritime Safety Queensland. These designs are consistent with relevant Australian standards with respect to shape, colours, lettering and symbols, as far as practicable. A regional office must not erect a marine sign that departs from these designs, without approval from the General Manager.

The Catalogue classifies marine safety signs according to their function:

Regulatory signs are used to regulate the operations and activities of vessels by indicating when or where a legal requirement applies. A failure to comply with a regulatory sign constitutes an offence against marine safety legislation.

Generally, regulatory signs are rectangular shaped with black letters or symbols, or both, with or without red annulus and slash, and with or without arrows, on white retroreflective background.

Included in this classification are marine safety signs that indicate the end of a legal requirement (for example, the END MARINE SPEED LIMIT sign).

Warning signs are used to warn waterway users of potentially hazardous conditions, or conditions that require caution and prudent seamanship, and may necessitate a reduction in speed to ensure safe navigation.

Generally, warning signs for waterways are rectangular shaped with black letters or symbols, or both, and black border on yellow retroreflective background.

Included in this classification are the warning signs for overhead powerlines.

Information signs inform or advise waterway users of matters of interest to the operation or activities of their vessels. These signs are individually designed to convey the appropriate marine safety message.

Generally, information signs for waterways are rectangular shaped with black or blue letters, with corresponding black or blue border, on white retroreflective background.

Suggestions or recommendations for new designs of marine safety signs must follow the basic shape,

colours lettering and symbols described for these particular classifications. This ensures consistency across MSQ's regions, which means that waterway users can easily recognise the different types of marine safety signs

REGULATORY SIGNS

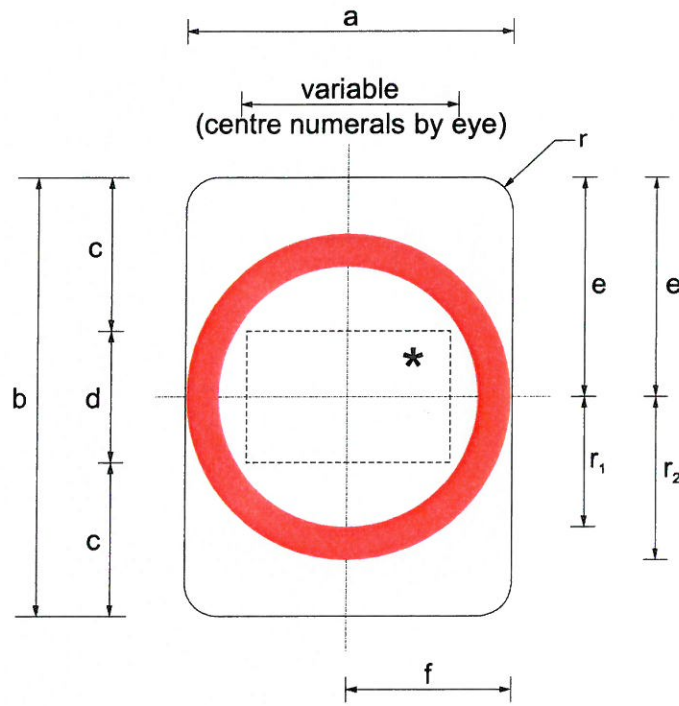

	a	b	c	d (1 numeral)	d (2 numerals)	e	f	r	r ₁	r ₂
SIZE A	450	600	210	200DN	180DN	300	225	45	178	223
SIZE B	600	800	280	260DN	240DN	400	300	60	237	297
SIZE C	900	1200	420	400DN	360DN	600	450	90	356	446
SIZE D	1200	1600	560	520DN	480DN	800	600	120	474	594



Examples

Colour Legend

-  Retroreflective white
-  Retroreflective red
-  Black

Notes:

1. This sign is an official traffic sign for a fixed marine speed limit under section 206A of the *Transport Operations (Marine Safety) Act 1994*.
2. The sign may be used on waterways to limit speeds to that indicated on the sign, consistent with the relevant gazette notice.
3. The sign may only be erected at locations approved by Maritime Safety Queensland within the Department of Transport and Main Roads. Contact the nearest regional office of Maritime Safety Queensland for the approval process.
- 4.*Insert appropriate speed in knots (e.g. 6).
5. Maritime Safety Queensland shall decide appropriate sign sizes according to the character of the waterway.



**Queensland
Government**

**REGULATORY SIGN
"MARINE SPEED LIMIT"**

Maritime Safety Queensland

Approved as a Marine Sign

P. G. W.

General Manager
Maritime Safety Queensland

01/02/14
Date

MS1001

Designed
TV 07/13

Checked
PK 07/13

Scale
Not to Scale

A			
---	--	--	--

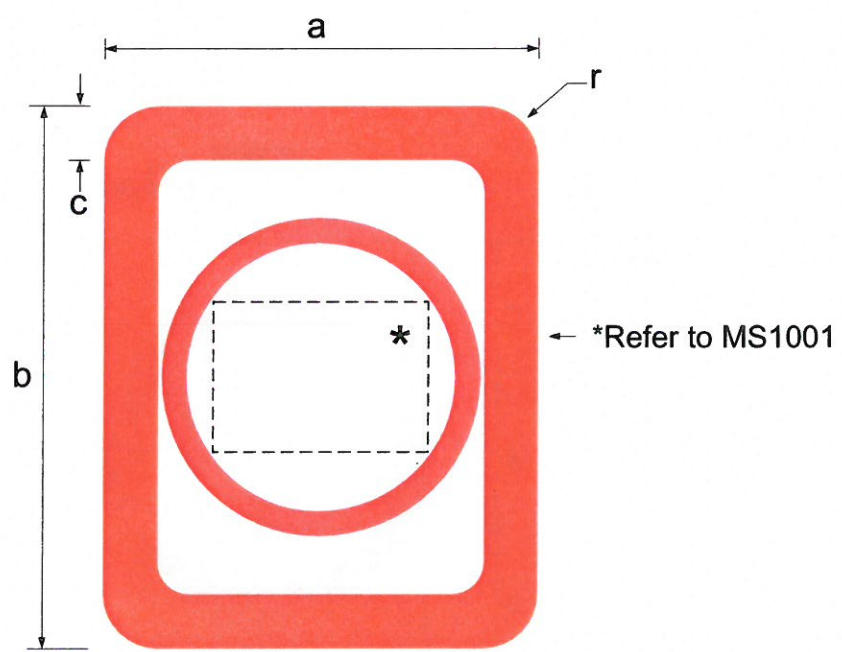

	a	b	c	r
A	600	750	75	75
B	800	1000	100	100
C	1200	1500	150	150
D	1600	2000	200	200

Notes:

1. This sign is an official traffic sign for a fixed marine speed limit under section 206A of the *Transport Operations (Marine Safety) Act 1994*, with the addition of a target board to increase visibility of the sign.
2. The sign may be used on waterways to limit speeds to that indicated on the sign, consistent with the relevant gazette notice.
3. The sign may only be erected at locations approved by Maritime Safety Queensland within the Department of Transport and Main Roads. Contact the nearest regional office of Maritime Safety Queensland for the approval process.
4. *Insert appropriate speed limit in knots (e.g. 6).
5. Refer to MS1001 for additional dimensions.
Maritime Safety Queensland shall decide appropriate sign sizes according to the character of the waterway.

Colour Legend

- Retroreflective white
- Retroreflective red
- Retroreflective orange

Queensland Government			REGULATORY SIGN "MARINE SPEED LIMIT WITH TARGET BOARD"		
Maritime Safety Queensland			Approved as a Marine Sign 		MS1001_1
Designed LC 02/14	Checked PK 02/14	Scale Not to Scale	General Manager Maritime Safety Queensland	01/02/14 Date	A

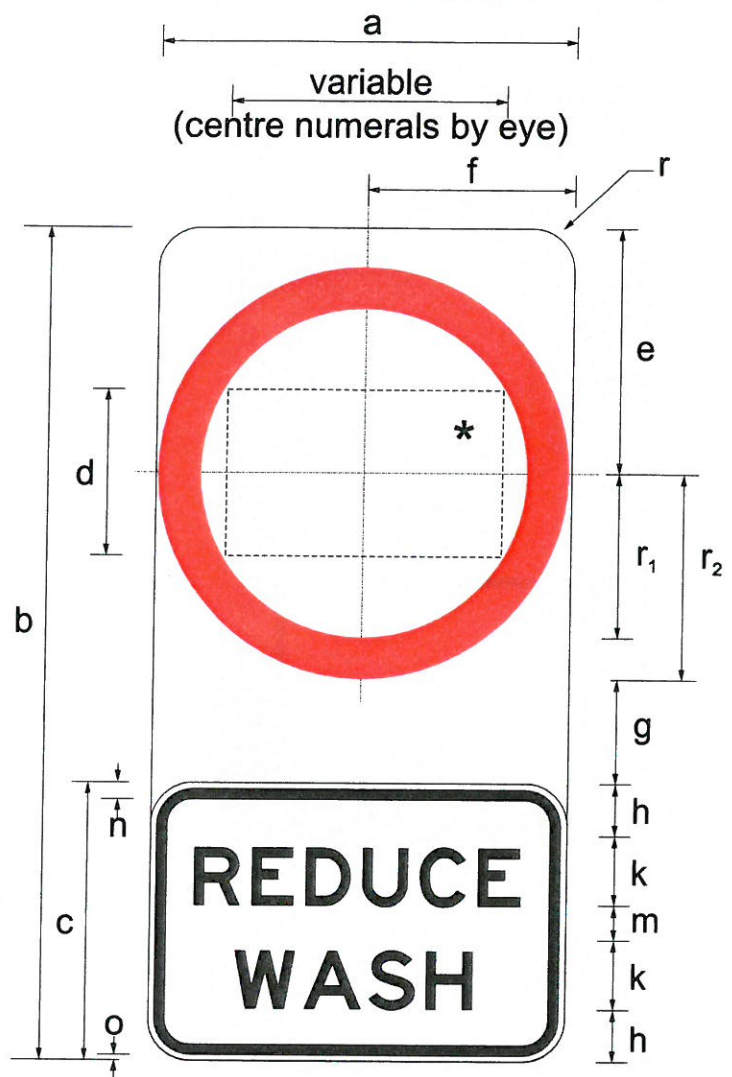

	a	b	c	d (2 numerals)	d (3 numerals)	e	f	g	h	k	m	n	o	r	r ₁	r ₂
SIZE A	450	900	300	200DN	-	265	225	115	55	75EN	40	18	6	45	185	220
SIZE B	600	1200	400	240DN	240CN	353	300	150	75	100EN	50	24	8	60	237	297
SIZE C	900	1800	600	400DN	320DN	530	450	225	110	150EN	80	30	10	90	365	445
SIZE D	1200	2400	800	480DN	480CN	708	600	300	150	200EN	100	48	16	120	485	592

Notes:

1. This sign is an official traffic sign for a fixed marine speed limit under section 206A of the *Transport Operations (Marine Safety) Act 1994*, with the addition of the words "Reduce Wash" to highlight the operational speed limit for wash under section 128 of the *Transport Operations (Marine Safety) Regulation 2004*.
2. The sign may be used on waterways to limit speeds to that indicated on the sign, consistent with the relevant gazette notice.
3. The sign may only be erected at locations approved by Maritime Safety Queensland within the Department of Transport and Main Roads. Contact the nearest regional office of Maritime Safety Queensland for the approval process.
4. *Insert appropriate speed in knots (e.g. 6).
5. Maritime Safety Queensland shall decide appropriate sign sizes according to the character of the waterway.

Colour Legend

- Retroreflective white
- Retroreflective red
- Black

Queensland Government			REGULATORY SIGN "MARINE SPEED LIMIT WITH REDUCE WASH"		
Maritime Safety Queensland			Approved as a Marine Sign General Manager Maritime Safety Queensland		MS1024_1
Designed LC 01/14	Checked PK 01/14	Scale Not to Scale	01/02/14 Date		A

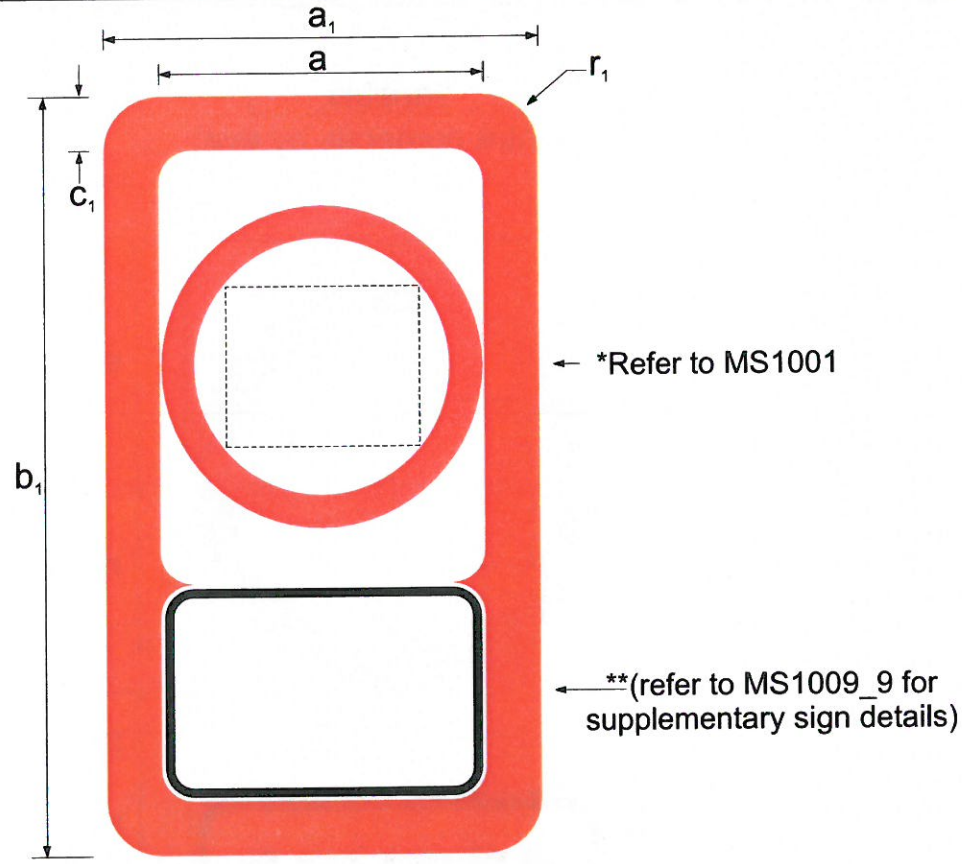

	a	a ₁	b ₁	c ₁	r ₁
SIZE A	450	600	1050	75	75
SIZE B	600	800	1400	100	100
SIZE C	900	1200	2100	150	150
SIZE D	1200	1600	2800	200	200

Notes:

1. This sign is an official traffic sign for a fixed marine speed limit under section 206A of the *Transport Operations (Marine Safety) Act 1994*, with the addition of the words "Reduce Wash" to highlight the operational speed limit for wash under section 128 of the *Transport Operations (Marine Safety) Regulation 2004*, as well as a target board to increase visibility of the sign.
2. The sign may be used on waterways to limit speeds to that indicated on the sign, consistent with the relevant gazette notice.
3. The sign may only be erected at locations approved by Maritime Safety Queensland within the Department of Transport and Main Roads. Contact the nearest regional office of Maritime Safety Queensland for the approval process.
4. *Insert appropriate speed limit in knots (e.g. 6).
5. Refer to MS1001 and MS1009_9 for additional dimensions.
6. Maritime Safety Queensland shall decide appropriate sign sizes according to the character of the waterway.

Colour Legend

- Retroreflective white
- Retroreflective red
- Black
- Retroreflective orange

Queensland Government			REGULATORY SIGN "MARINE SPEED LIMIT WITH REDUCE WASH AND TARGET BOARD"		
Maritime Safety Queensland			Approved as a Marine Sign		MS1024_2
Designed LC 01/14	Checked PK 01/14	Scale Not to Scale	General Manager Maritime Safety Queensland		
					A

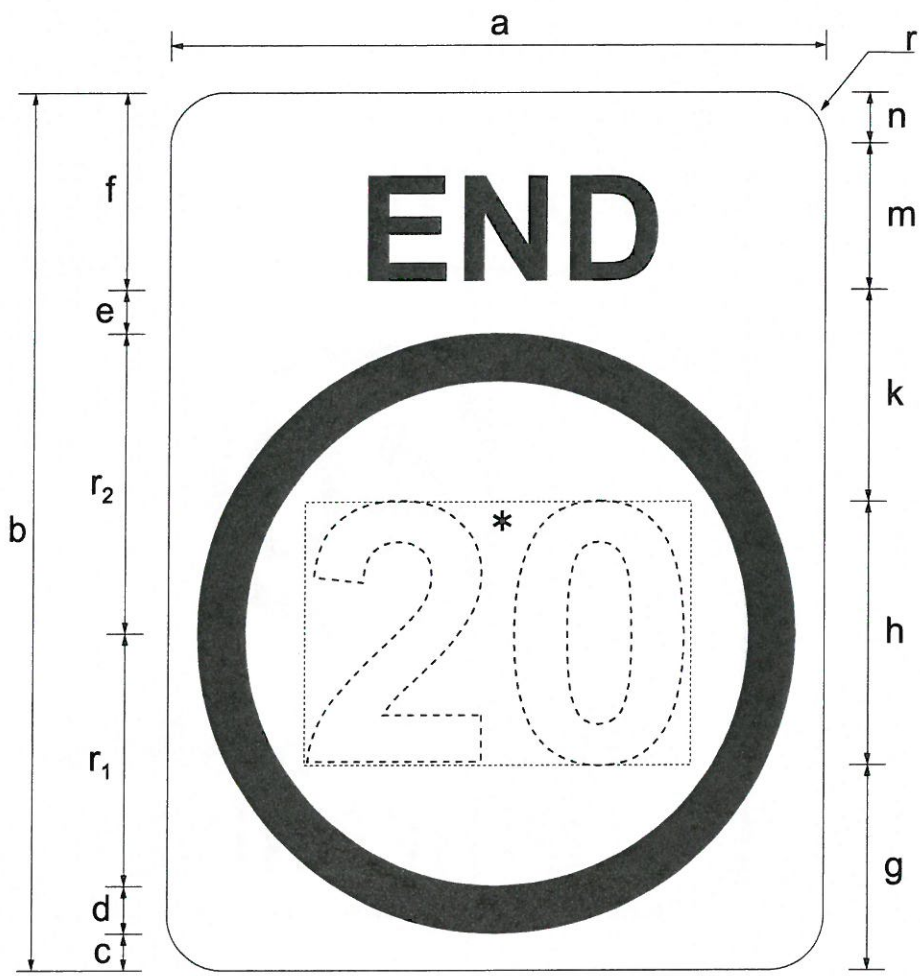

	a	b	c	d	e	f	g	h	k	m	n	r ₁	r ₂	r
SIZE A	600	800	32	44	40	180	187	240DN	193	135EM	45	230	274	50
SIZE B	900	1200	50	65	60	270	280	360DN	290	200EM	70	345	410	75

Colour Legend

- Retroreflective white
- Black

Notes:

1. This sign is an official traffic sign for a fixed marine speed limit under section 206A of the *Transport Operations (Marine Safety) Act 1994*.
2. The sign is used to terminate a speed when it is not practical or desirable to display the speed limit applying beyond a current zone.
3. The sign may only be erected at locations approved by Maritime Safety Queensland within the Department of Transport and Main Roads. Contact the nearest regional office of Maritime Safety Queensland for the approval process.
- 4.*Insert appropriate speed in knots (e.g. 20).
5. Maritime Safety Queensland shall decide appropriate sign sizes according to the character of the waterway.



Queensland Government

REGULATORY SIGN
"END MARINE SPEED LIMIT"

Maritime Safety Queensland

Approved as a Marine Sign

P. G. W.

General Manager
Maritime Safety Queensland

01/02/14
Date

MS1002

Designed
TV 07/13

Checked
PK 07/13

Scale
Not to Scale

A				
---	--	--	--	--

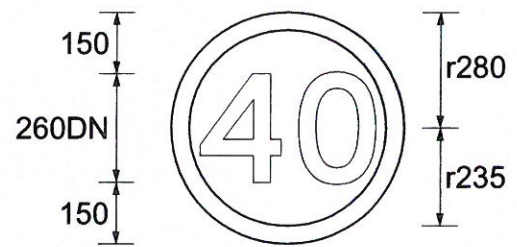

Colour Legend

- Retroreflective white
- Retroreflective red
- Black

Notes

1. This sign is an official traffic sign for a fixed marine speed limit under section 206A of the *Transport Operations (Marine Safety) Act 1994*.
2. The sign may only be erected at locations approved by Maritime Safety Queensland within the Department of Transport and Main Roads. Contact the nearest regional office of Maritime Safety Queensland for the approval process.
3. The sign describes the maximum speed limit of 40 knots for smooth waters.

Queensland Government			REGULATORY SIGN "SMOOTH WATERS SPEED LIMIT UNLESS SIGNED OTHERWISE"		
Maritime Safety Queensland			Approved as a Marine Sign		MS1003
Designed TV 07/13	Checked PK 07/13	Scale Not to Scale	General Manager Maritime Safety Queensland		
			01/02/14 Date	A	

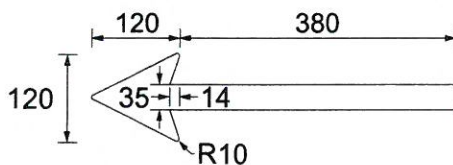
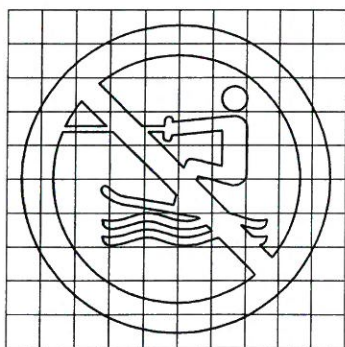

Target board example *

Colour Legend

- Retroreflective white
- Retroreflective red
- Retroreflective orange
- Black

Notes

1. This sign shall be used to inform vessel masters of a water skiing prohibition under section 221(3) of the *Transport Operations (Marine Safety) Regulation 2004*.
2. The sign may only be erected at locations approved by Maritime Safety Queensland within the Department of Transport and Main Roads. Contact the nearest regional office of Maritime Safety Queensland for the approval process.
3. * A retroreflective orange target board of minimum 100 mm width may be added to the sign where it is considered the prohibition should be highlighted.



Queensland Government

REGULATORY SIGN
"WATER SKIING PROHIBITED" - TO LEFT

Maritime Safety Queensland

Approved as a Marine Sign

MS1004_1

Designed
TV 07/13

Checked
PK 07/13

Scale
Not to Scale

General Manager
Maritime Safety Queensland

01/02/14
Date

Page 1 of 3

A				
---	--	--	--	--

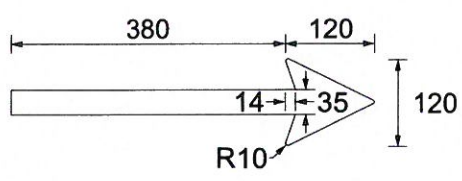
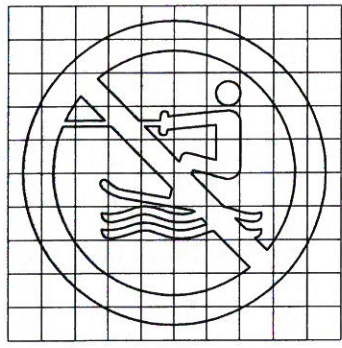

Target board example *

Colour Legend

- Retroreflective white
- Retroreflective red
- Retroreflective orange
- Black

Notes

1. This sign shall be used to inform vessel masters of a water skiing prohibition under section 221(3) of the *Transport Operations (Marine Safety) Regulation 2004*.
2. The sign may only be erected at locations approved by Maritime Safety Queensland within the Department of Transport and Main Roads. Contact the nearest regional office of Maritime Safety Queensland for the approval process.
3. * A retroreflective orange target board of minimum 100 mm width may be added to the sign where it is considered the prohibition should be highlighted.

Queensland Government			REGULATORY SIGN "WATER SKIING PROHIBITED" - TO RIGHT		
Maritime Safety Queensland			Approved as a Marine Sign		MS1004_2 Page 2 of 3
Designed TV 07/13	Checked PK 07/13	Scale Not to Scale	General Manager Maritime Safety Queensland		
					A

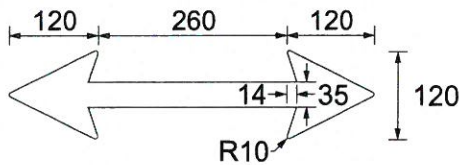
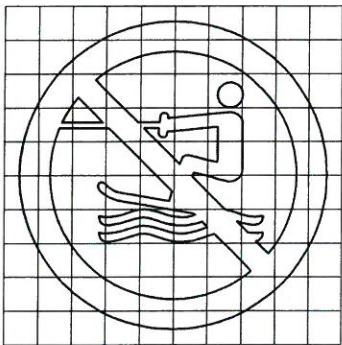

Target board example *

Colour Legend

- Retroreflective white
- Retroreflective red
- Retroreflective orange
- Black

Notes

1. This sign shall be used to inform vessel masters of a water skiing prohibition under section 221(3) of the *Transport Operations (Marine Safety) Regulation 2004*.
2. The sign may only be erected at locations approved by Maritime Safety Queensland within the Department of Transport and Main Roads. Contact the nearest regional office of Maritime Safety Queensland for the approval process.
3. * A retroreflective orange target board of minimum 100 mm width may be added to the sign where it is considered the prohibition should be highlighted.



**Queensland
Government**

REGULATORY SIGN
"WATER SKIING PROHIBITED" - BOTH WAYS

Maritime Safety Queensland

Approved as a Marine Sign

P. G. W.

General Manager
Maritime Safety Queensland

01/02/14
Date

MS1004_3

Page 3 of 3

Designed
TV 07/13

Checked
PK 07/13

Scale
Not to Scale

A			
---	--	--	--

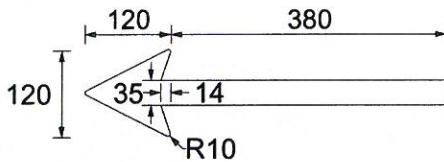
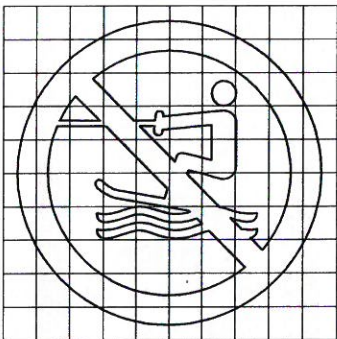
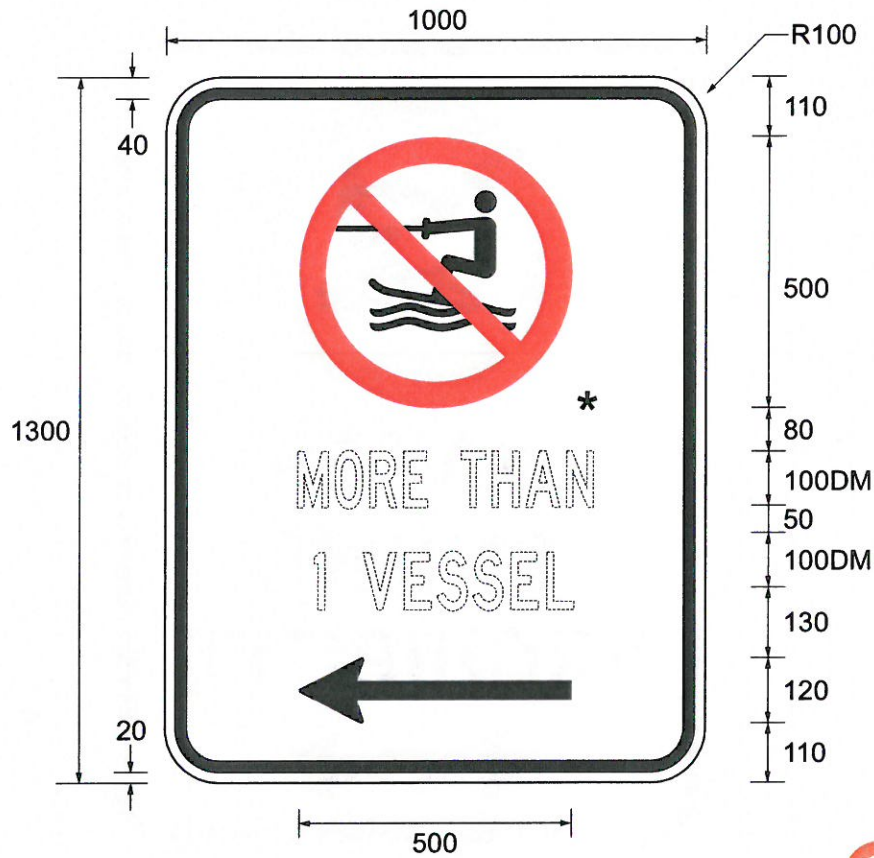

Target board example **

Colour Legend

- Retroreflective white
- Retroreflective red
- Retroreflective orange
- Black

Notes

1. This sign shall be used to inform vessel masters of a water skiing prohibition under section 221(3) of the *Transport Operations (Marine Safety) Regulation 2004*, where water skiing is also regulated by specific conditions.
2. *The variable text field shall be populated to accurately describe the water skiing conditions, in accordance with the relevant gazette notice.
3. The sign may only be erected at locations approved by Maritime Safety Queensland within the Department of Transport and Main Roads. Contact the nearest regional office of Maritime Safety Queensland for the approval process
4. **A retroreflective orange target board of minimum 100 mm width may be added to the sign for locations where the information should be highlighted.



Queensland Government

REGULATORY SIGN
"WATER SKIING PROHIBITED"
(LEFT)

Maritime Safety Queensland

Approved as a Marine Sign

P. G. W.
 General Manager
 Maritime Safety Queensland

01/02/14
 Date

MS1005_1

Page 1 of 3

Designed
 TV 07/13

Checked
 PK 07/13

Scale
 Not to Scale

A			
---	--	--	--

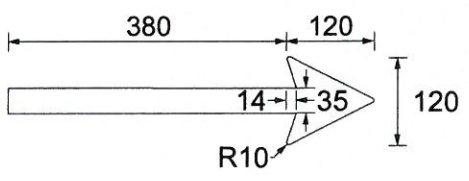
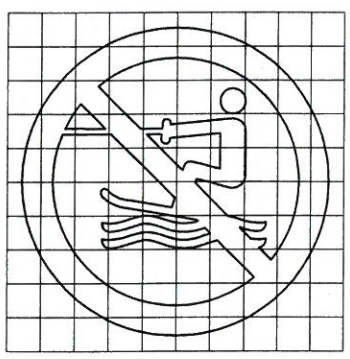
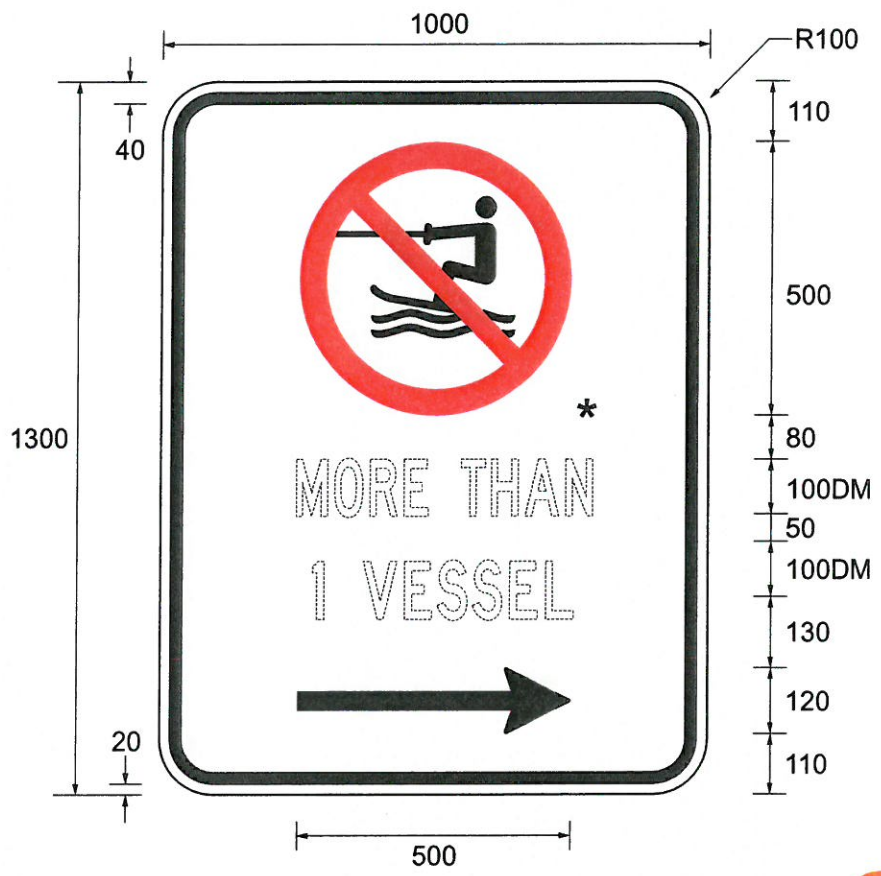

Target board example **

Colour Legend

- Retroreflective white
- Retroreflective red
- Retroreflective orange
- Black

Notes

1. This sign shall be used to inform vessel masters of a water skiing prohibition under section 221(3) of the *Transport Operations (Marine Safety) Regulation 2004*, where water skiing is also regulated by specific conditions.
2. *The variable text field shall be populated to accurately describe the water skiing conditions, in accordance with the relevant gazette notice.
3. The sign may only be erected at locations approved by Maritime Safety Queensland within the Department of Transport and Main Roads. Contact the nearest regional office of Maritime Safety Queensland for the approval process
4. **A retroreflective orange target board of minimum 100 mm width may be added to the sign for locations where the information should be highlighted.



Queensland Government

REGULATORY SIGN
 "WATER SKIING PROHIBITED"
 (RIGHT)

Maritime Safety Queensland

Approved as a Marine Sign

General Manager
 Maritime Safety Queensland

01/02/14
 Date

MS1005_2

Page 2 of 3

Designed
 TV 07/13

Checked
 PK 07/13

Scale
 Not to Scale

A			
---	--	--	--

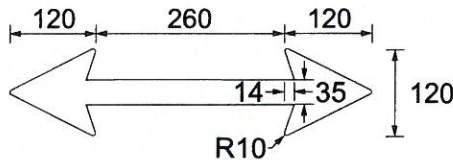
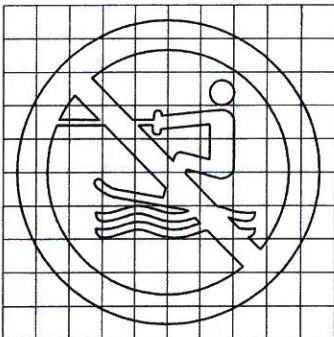
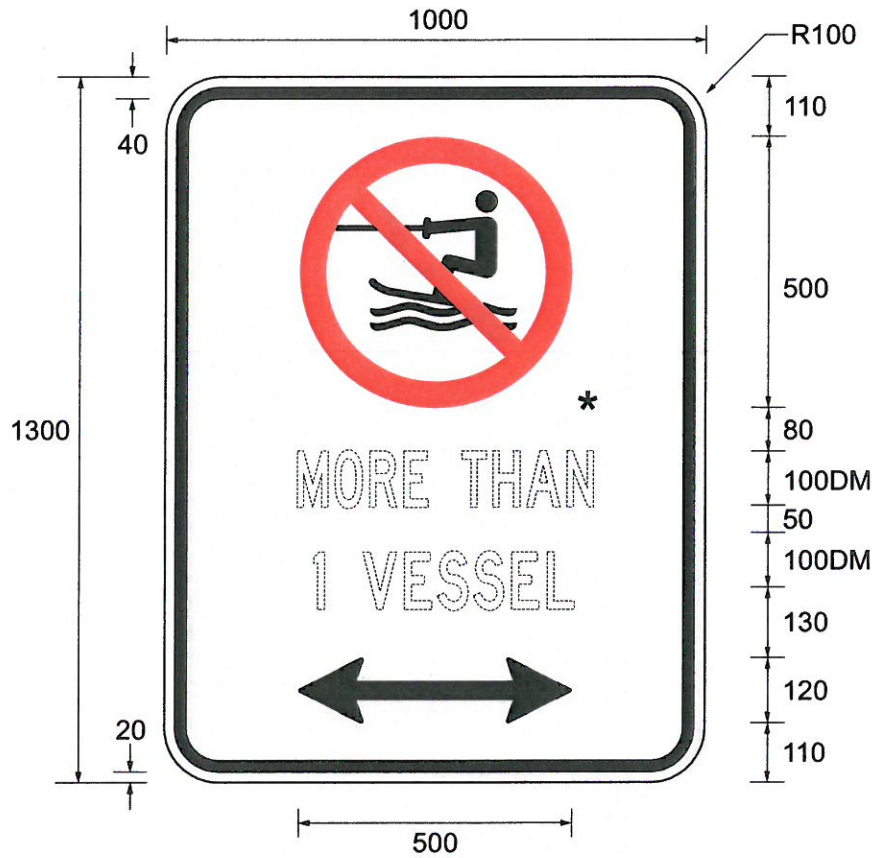

Target board example **

Colour Legend

- Retroreflective white
- Retroreflective red
- Retroreflective orange
- Black

Notes

1. This sign shall be used to inform vessel masters of a water skiing prohibition under section 221(3) of the *Transport Operations (Marine Safety) Regulation 2004*, where water skiing is also regulated by specific conditions.
2. *The variable text field shall be populated to accurately describe the water skiing conditions, in accordance with the relevant gazette notice.
3. The sign may only be erected at locations approved by Maritime Safety Queensland within the Department of Transport and Main Roads. Contact the nearest regional office of Maritime Safety Queensland for the approval process
4. **A retroreflective orange target board of minimum 100 mm width may be added to the sign for locations where the information should be highlighted.



**Queensland
Government**

REGULATORY SIGN
"WATER SKIING PROHIBITED"
(BOTH WAYS)

Maritime Safety Queensland

Approved as a Marine Sign

P. G. W.
General Manager
Maritime Safety Queensland

01/02/14
Date

MS1005_3

Page 3 of 3

Designed
TV 07/13

Checked
PK 07/13

Scale
Not to Scale

A

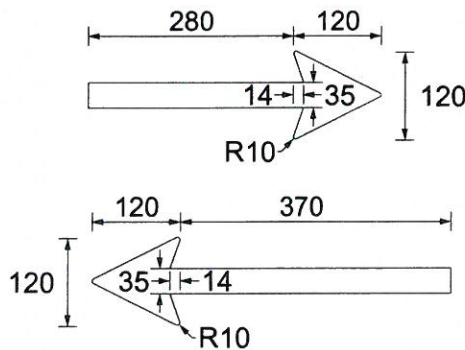
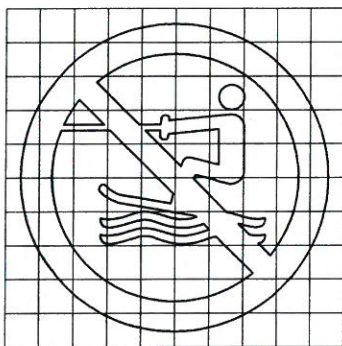
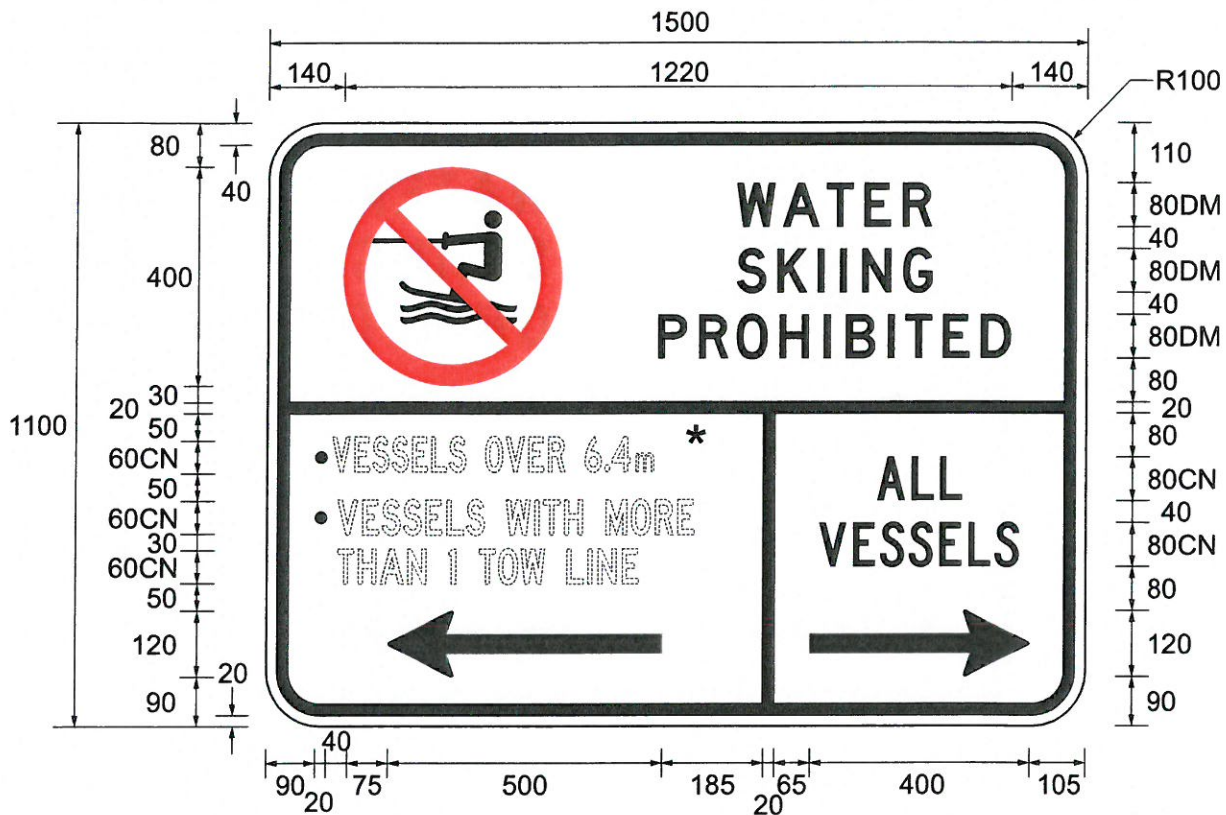

Target board example **

Notes

1. This sign shall be used to inform vessel masters of a water skiing prohibition under section 221(3) of the *Transport Operations (Marine Safety) Regulation 2004*, where water skiing is also regulated by specific conditions.
2. *The variable text field shall be populated to accurately describe the water skiing conditions, in accordance with the relevant gazette notice.
3. The sign may only be erected at locations approved by Maritime Safety Queensland within the Department of Transport and Main Roads. Contact the nearest regional office of Maritime Safety Queensland for the approval process.
4. ** A retroreflective orange target board of minimum 100 mm width may be added to the sign where it is considered the message should be highlighted.
5. See page MS1006_2 for reverse direction option.

Colour Legend

- Retroreflective white
- Retroreflective red
- Retroreflective orange
- Black



Queensland Government

REGULATORY SIGN
"WATER SKIING PROHIBITED"

Maritime Safety Queensland

Approved as a Marine Sign

General Manager
Maritime Safety Queensland

01/02/14
Date

MS1006_1

Page 1 of 2

Designed
TV 07/13

Checked
PK 07/13

Scale
Not to Scale

A			
---	--	--	--

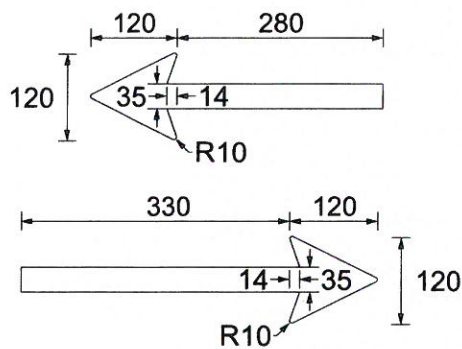
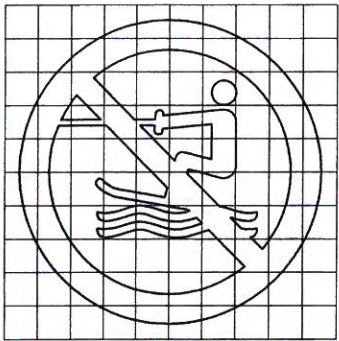
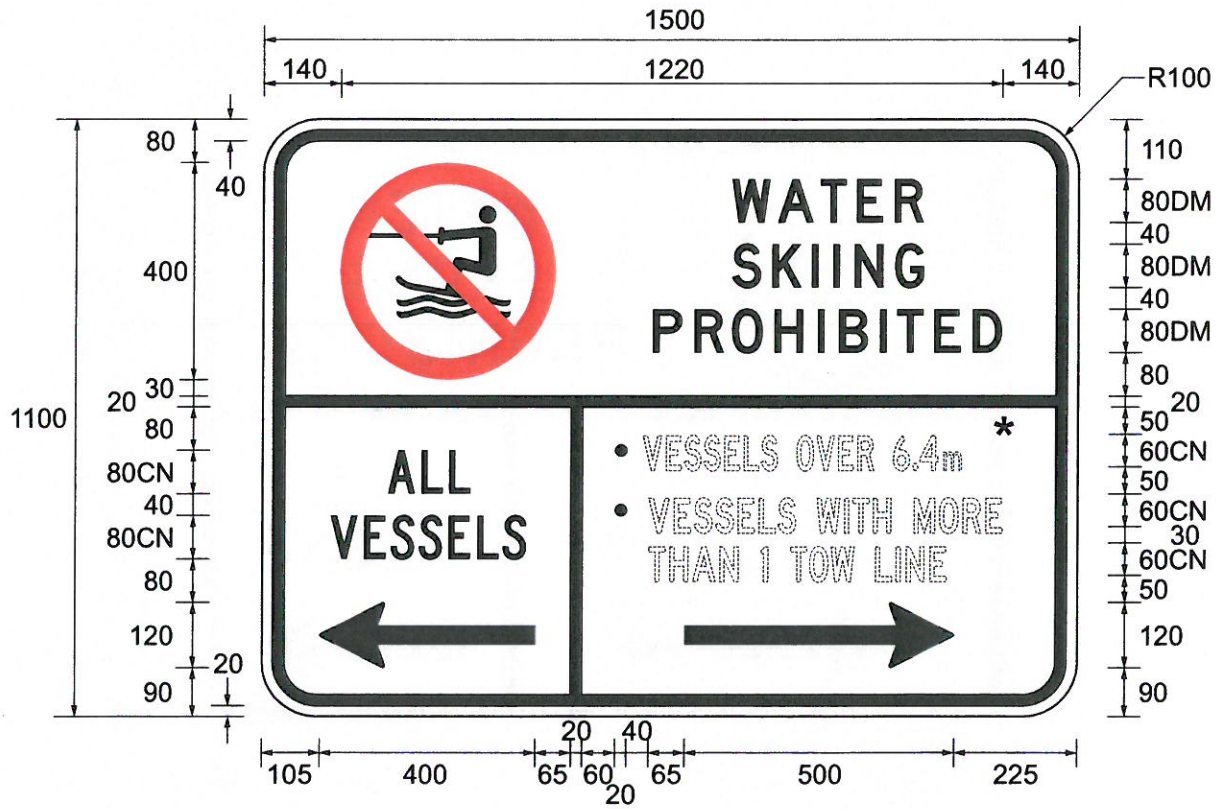

Target board example **

Notes

1. This sign shall be used to inform vessel masters of a water skiing prohibition under section 221(3) of the *Transport Operations (Marine Safety) Regulation 2004*, where water skiing is also regulated by specific conditions.
2. *The variable text field shall be populated to accurately describe the water skiing conditions, in accordance with the relevant gazette notice.
3. The sign may only be erected at locations approved by Maritime Safety Queensland within the Department of Transport and Main Roads. Contact the nearest regional office of Maritime Safety Queensland for the approval process.
4. ** A retroreflective orange target board of minimum 100 mm width may be added to the sign where it is considered the message should be highlighted.
5. See page MS1006_1 for reverse direction option.

Colour Legend

- Retroreflective white
- Retroreflective red
- Retroreflective orange
- Black



**Queensland
Government**

**REGULATORY SIGN
"WATER SKIING PROHIBITED"**

Maritime Safety Queensland

Approved as a Marine Sign

P. G. W.
General Manager
Maritime Safety Queensland

01/02/14
Date

MS1006_2

Designed
TV 07/13

Checked
PK 07/13

Scale
Not to Scale

A			
---	--	--	--

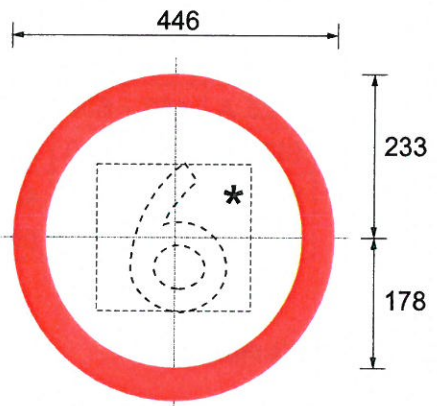
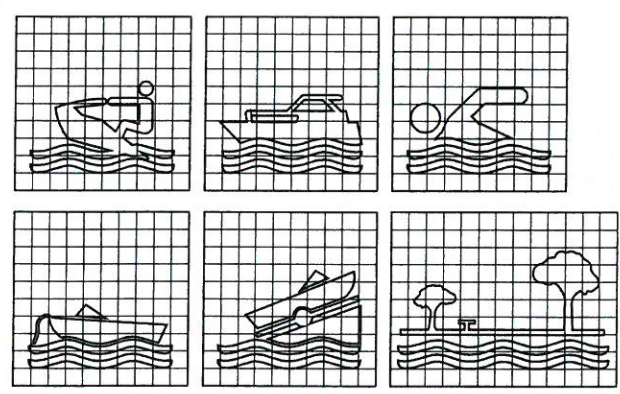
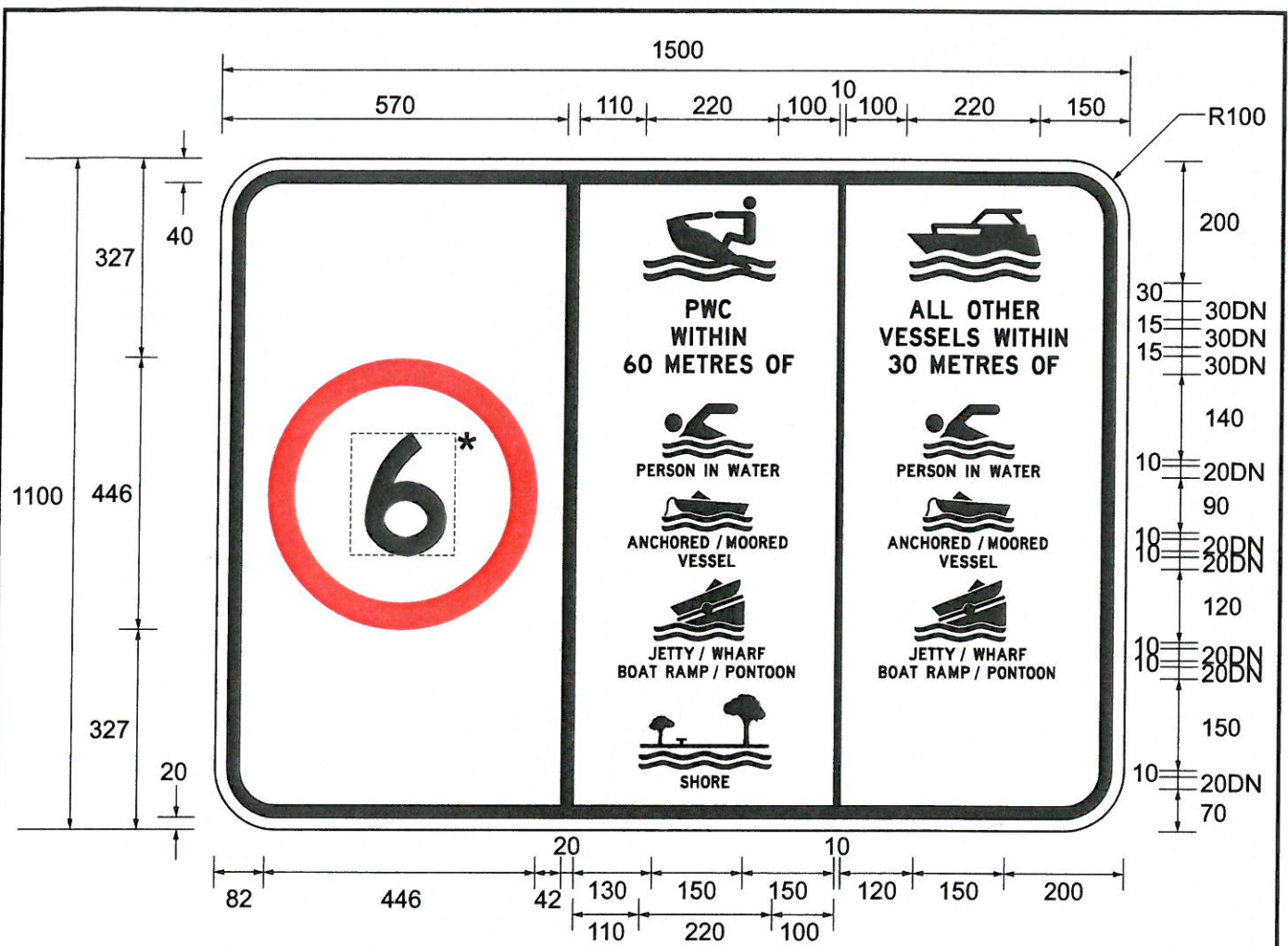

Colour Legend

- Retroreflective white
- Retroreflective red
- Black

Notes

1. This sign is an official traffic sign for operational speed limits under sections 127 and 127A of the *Transport Operations (Marine Safety) Regulation 2004*.
2. The sign may only be erected at locations approved by Maritime Safety Queensland within the Department of Transport and Main Roads. Contact the nearest regional office of Maritime Safety Queensland for the approval process.
3. * Insert appropriate speed limit in knots as required.



REGULATORY SIGN
"OPERATIONAL SPEED LIMITS"

Maritime Safety Queensland

Approved as a Marine Sign

General Manager
Maritime Safety Queensland

01/02/14
Date

MS1007

Designed TV 07/13	Checked PK 07/13	Scale Not to Scale
----------------------	---------------------	-----------------------

A			
---	--	--	--

41

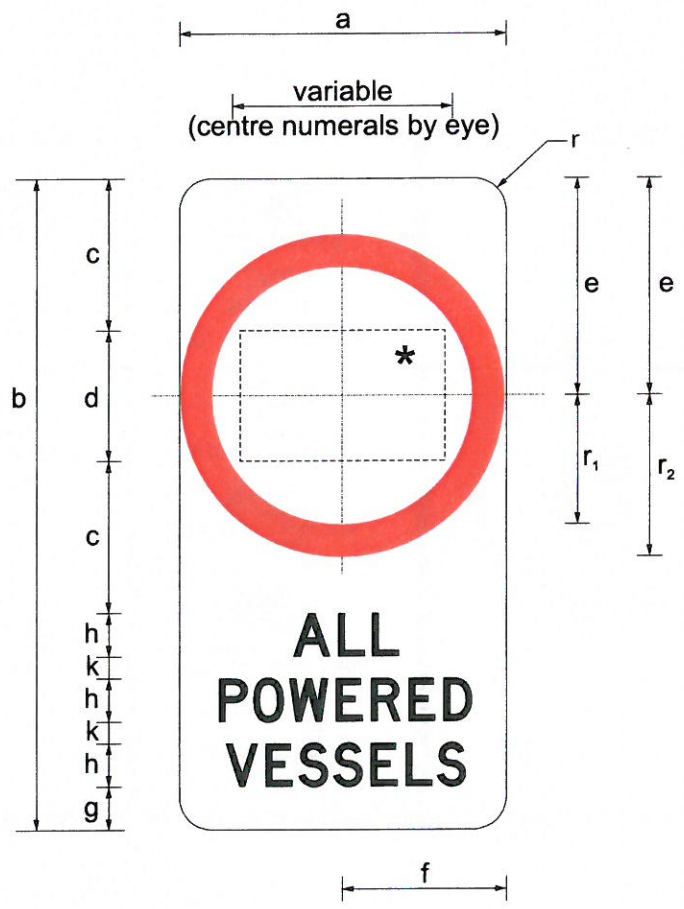

Example

	a	b	c	d (1 numeral)	d (2 numerals)	e	f	g	h	k	r	r ₁	r ₂
SIZE A	450	600	210	200DN	180DN	300	225	60	60DN	30	45	178	223
SIZE B	600	800	280	260DN	240DN	400	300	300	80DN	40	60	237	297
SIZE C	900	1200	420	400DN	360DN	600	450	450	120DN	60	90	356	446
SIZE D	1200	1600	560	520DN	480DN	800	600	600	160DN	80	120	474	594

Notes

1. This sign is an official traffic sign for a fixed marine speed limit under section 206A of the *Transport Operations (Marine Safety) Act 1994*.
2. The sign may be used on waterways to limit the speed of all powered vessels, consistent with the relevant gazette notice.
3. The sign may only be erected at locations approved by Maritime Safety Queensland within the Department of Transport and Main Roads. Contact the nearest regional office of Maritime Safety Queensland for the approval process.
4. *Insert appropriate speed in knots (e.g. 6).
5. Maritime Safety Queensland shall decide appropriate sign sizes according to the character of the waterway.

Colour Legend

- Retroreflective white
- Retroreflective red
- Black

Queensland Government			REGULATORY SIGN "MARINE SPEED LIMIT ALL POWERED VESSELS"		
Maritime Safety Queensland			Approved as a Marine Sign		MS1008_1 Page 1 of 8
Designed TV 07/13	Checked PK 07/13	Scale Not to Scale	General Manager Maritime Safety Queensland		
			A		

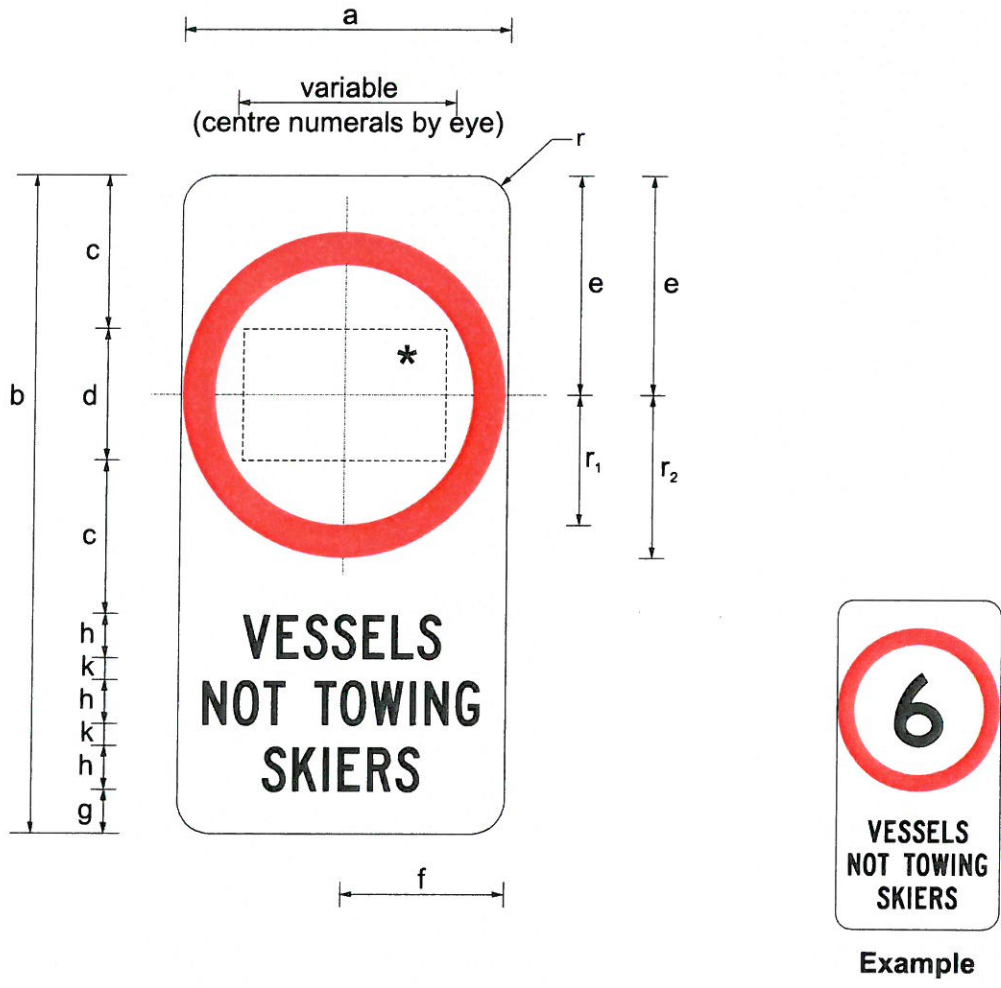

	a	b	c	d (1 numeral)	d (2 numerals)	e	f	g	h	k	r	r ₁	r ₂
SIZE A	450	600	210	200DN	180DN	300	225	60	60CN	30	45	178	223
SIZE B	600	800	280	260DN	240DN	400	300	300	80CN	40	60	237	297
SIZE C	900	1200	420	400DN	360DN	600	450	450	120CN	60	90	356	446
SIZE D	1200	1600	560	520DN	480DN	800	600	600	160CN	80	120	474	594

Notes

1. This sign is an official traffic sign for a fixed marine speed limit under section 206A of the *Transport Operations (Marine Safety) Act 1994*.
2. The sign may be used on waterways to limit the speed of vessels not towing water skiers, consistent with the relevant gazette notice.
3. The sign may only be erected at locations approved by Maritime Safety Queensland within the Department of Transport and Main Roads. Contact the nearest regional office of Maritime Safety Queensland for the approval process.
4. *Insert appropriate speed in knots (e.g. 6).
5. Maritime Safety Queensland shall decide appropriate sign sizes according to the character of the waterway.

Colour Legend

- Retroreflective white
- Retroreflective red
- Black

Queensland Government			REGULATORY SIGN "MARINE SPEED LIMIT VESSELS NOT TOWING SKIERS"		
Maritime Safety Queensland			Approved as a Marine Sign		MS1008_2
Designed TV 07/13	Checked PK 07/13	Scale Not to Scale	 General Manager Maritime Safety Queensland		
			01/02/14	Date	Page 2 of 8
			A		

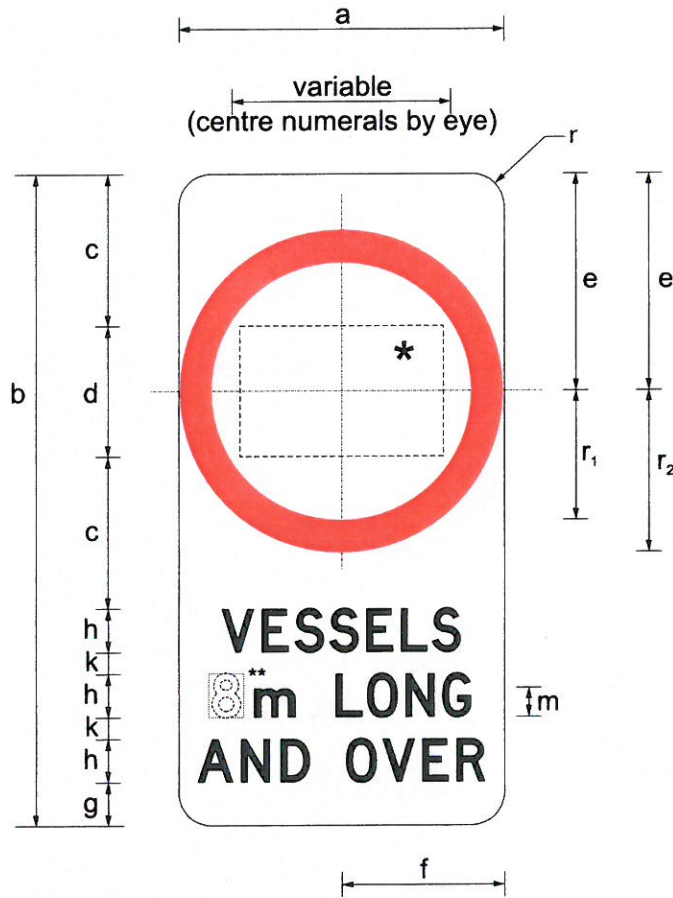

Example

	a	b	c	d (1 numeral)	d (2 numerals)	e	f	g	h	k	m	r	r ₁	r ₂
SIZE A	450	600	210	200DN	180DN	300	225	60	60DN	30	40LC	45	178	223
SIZE B	600	800	280	260DN	240DN	400	300	300	80DN	40	55LC	60	237	297
SIZE C	900	1200	420	400DN	360DN	600	450	450	120DN	60	80LC	90	356	446
SIZE D	1200	1600	560	520DN	480DN	800	600	600	160DN	80	110LC	120	474	594

Notes

1. This sign is an official traffic sign for a fixed marine speed limit under section 206A of the *Transport Operations (Marine Safety) Act 1994*.
2. The sign may be used on waterways to limit the speed of longer vessels, consistent with the relevant gazette notice.
3. The sign may only be erected at locations approved by Maritime Safety Queensland within the Department of Transport and Main Roads. Contact the nearest regional office of Maritime Safety Queensland for the approval process.
4. *Insert appropriate speed in knots (e.g. 6).
5. **Length may vary as required.
6. Maritime Safety Queensland shall decide appropriate sign sizes according to the character of the waterway.

Colour Legend

- Retroreflective white
- Retroreflective red
- Black



Queensland Government

REGULATORY SIGN
"MARINE SPEED LIMIT
VESSELS ...m LONG AND OVER"

Maritime Safety Queensland

Approved as a Marine Sign

P. C. W.
 General Manager
 Maritime Safety Queensland

01/02/14
 Date

MS1008_3

Page 3 of 8

Designed
 TV 07/13

Checked
 PK 07/13

Scale
 Not to Scale

A

--	--	--	--

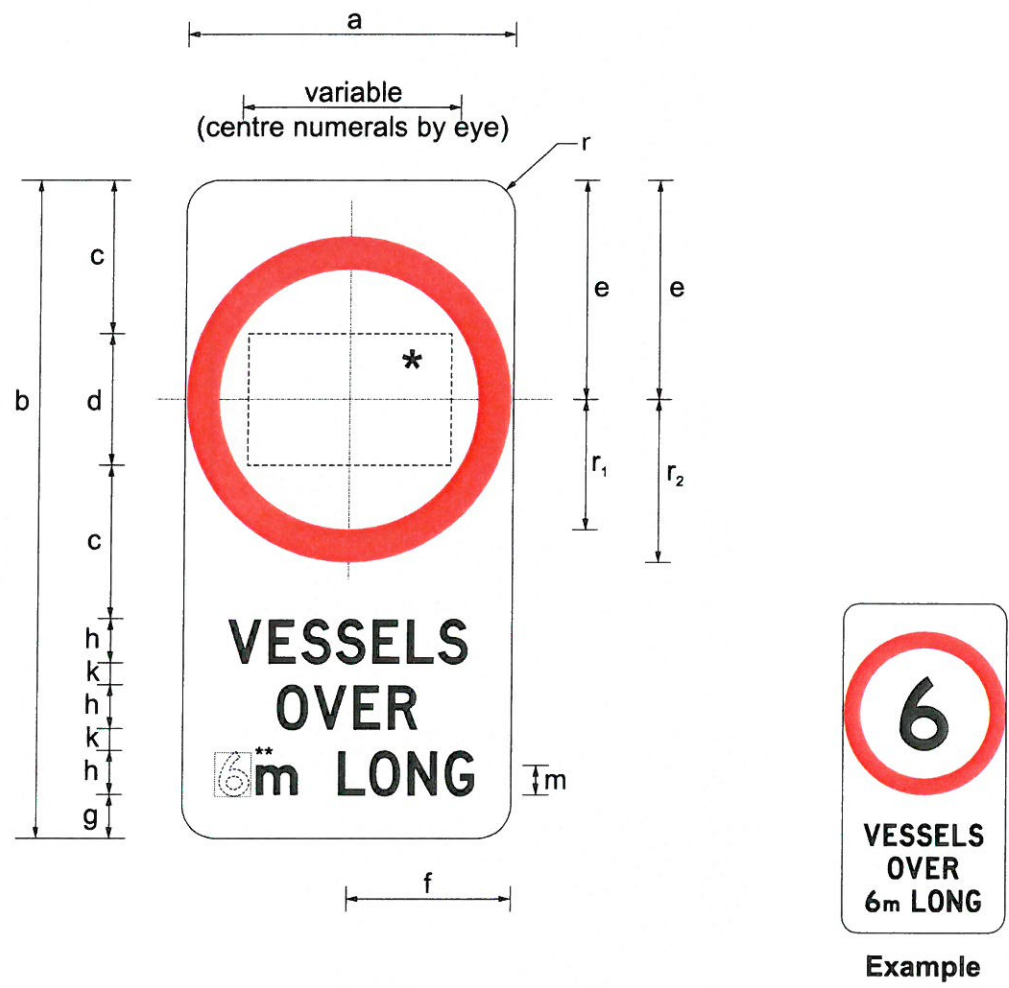

	a	b	c	d (1 numeral)	d (2 numerals)	e	f	g	h	k	m	r	r ₁	r ₂
SIZE A	450	600	210	200DN	180DN	300	225	60	60DN	30	40LC	45	178	223
SIZE B	600	800	280	260DN	240DN	400	300	300	80DN	40	55LC	60	237	297
SIZE C	900	1200	420	400DN	360DN	600	450	450	120DN	60	80LC	90	356	446
SIZE D	1200	1600	560	520DN	480DN	800	600	600	160DN	80	110LC	120	474	594

Notes

1. This sign is an official traffic sign for a fixed marine speed limit under section 206A of the *Transport Operations (Marine Safety) Act 1994*.
2. The sign may be used on waterways to limit the speed of vessels over 6 metres in length, consistent with the relevant gazette notice.
3. The sign may only be erected at locations approved by Maritime Safety Queensland within the Department of Transport and Main Roads. Contact the nearest regional office of Maritime Safety Queensland for the approval process.
4. *Insert appropriate speed in knots (e.g. 6).
5. **Length may vary as required.
6. Maritime Safety Queensland shall decide appropriate sign sizes according to the character of the waterway.

Colour Legend

- Retroreflective white
- Retroreflective red
- Black

Queensland Government			REGULATORY SIGN "MARINE SPEED LIMIT VESSELS OVER ...m LONG"		
Maritime Safety Queensland			Approved as a Marine Sign 		MS1008_4
Designed TV 07/13	Checked PK 07/13	Scale Not to Scale	General Manager Maritime Safety Queensland	01/02/14 Date	Page 4 of 8 A

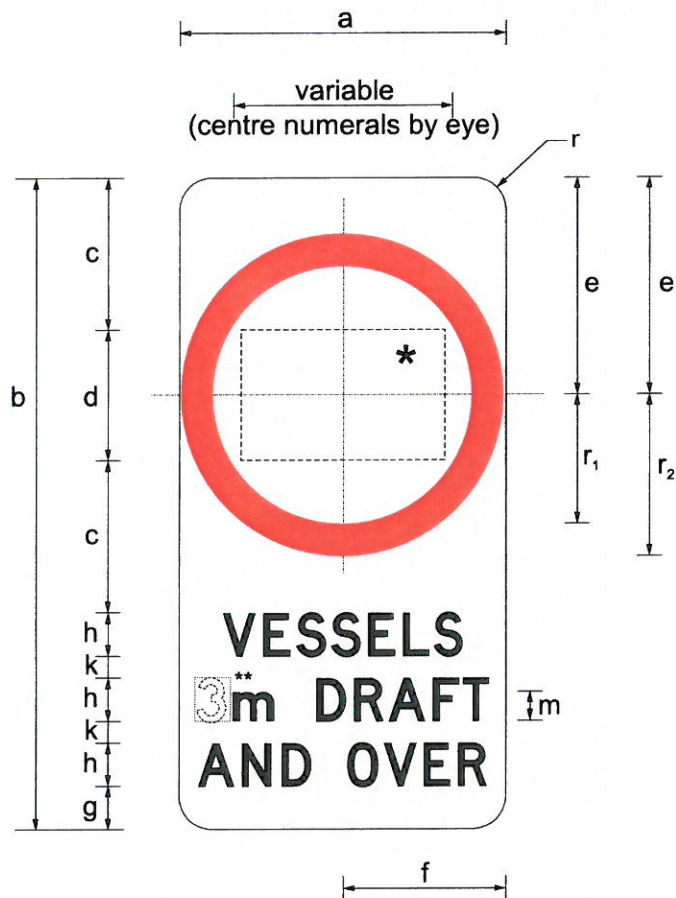

Example

	a	b	c	d (1 numeral)	d (2 numerals)	e	f	g	h	k	m	r	r ₁	r ₂
SIZE A	450	600	210	200DN	180DN	300	225	60	60DN	30	40LC	45	178	223
SIZE B	600	800	280	260DN	240DN	400	300	300	80DN	40	55LC	60	237	297
SIZE C	900	1200	420	400DN	360DN	600	450	450	120DN	60	80LC	90	356	446
SIZE D	1200	1600	560	520DN	480DN	800	600	600	160DN	80	110LC	120	474	594

Notes

1. This sign is an official traffic sign for a fixed marine speed limit under section 206A of the *Transport Operations (Marine Safety) Act 1994*.
2. The sign may be used on waterways to limit the speed of vessels with a draft of 3 metres and over, consistent with the relevant gazette notice.
3. The sign may only be erected at locations approved by Maritime Safety Queensland within the Department of Transport and Main Roads. Contact the nearest regional office of Maritime Safety Queensland for the approval process.
4. *Insert appropriate speed in knots (e.g. 6).
5. **Draft may vary as required.
6. Maritime Safety Queensland shall decide appropriate sign sizes according to the character of the waterway.

Colour Legend

- Retroreflective white
- Retroreflective red
- Black

Queensland Government			REGULATORY SIGN "MARINE SPEED LIMIT VESSELS ...m DRAFT AND OVER"		
Maritime Safety Queensland			Approved as a Marine Sign		MS1008_5 Page 5 of 8
Designed TV 07/13	Checked PK 07/13	Scale Not to Scale	General Manager Maritime Safety Queensland		
			A		

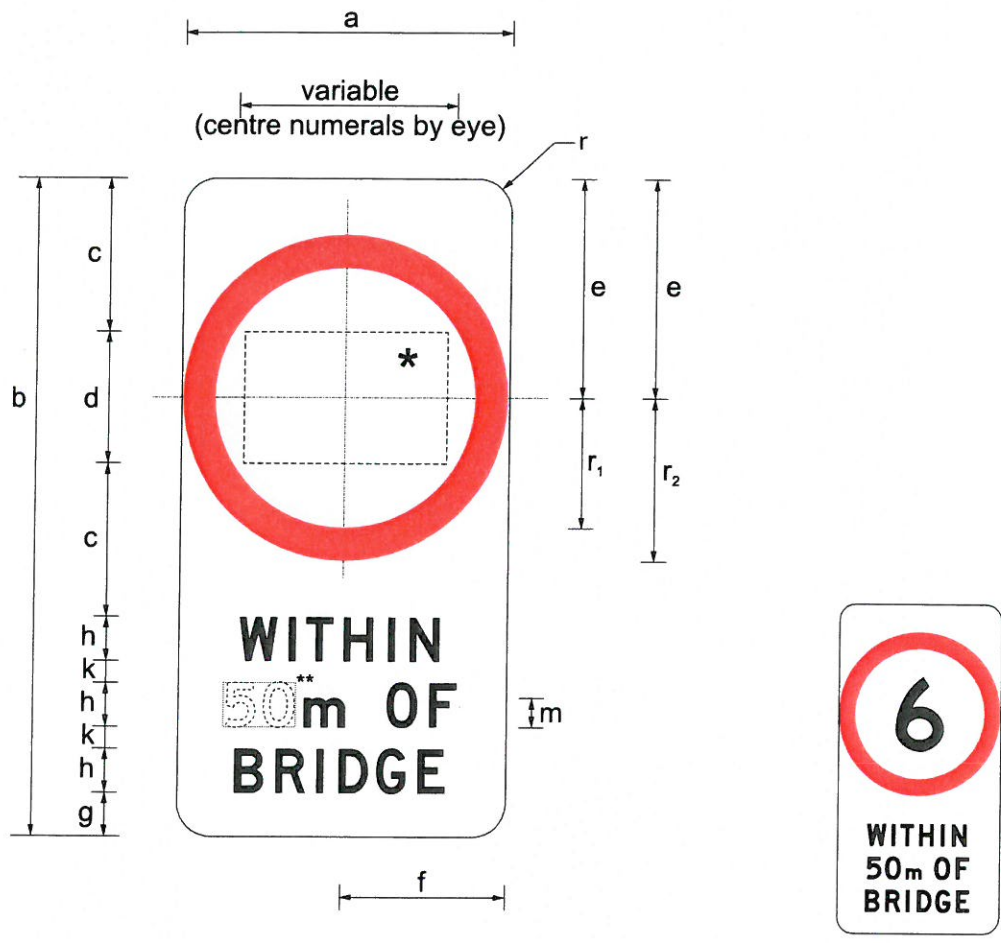

Example

	a	b	c	d (1 numeral)	d (2 numerals)	e	f	g	h	k	m	r	r ₁	r ₂
SIZE A	450	600	210	200DN	180DN	300	225	60	60DM	30	40LC	45	178	223
SIZE B	600	800	280	260DN	240DN	400	300	300	80DM	40	55LC	60	237	297
SIZE C	900	1200	420	400DN	360DN	600	450	450	120DM	60	80LC	90	356	446
SIZE D	1200	1600	560	520DN	480DN	800	600	600	160DM	80	110LC	120	474	594

Notes

1. This sign is an official traffic sign for a fixed marine speed limit under section 206A of the *Transport Operations (Marine Safety) Act 1994*.
2. The sign may be used on waterways to limit the speed of vessels near a bridge, consistent with the relevant gazette notice.
3. The sign may only be erected at locations approved by Maritime Safety Queensland within the Department of Transport and Main Roads. Contact the nearest regional office of Maritime Safety Queensland for the approval process.
4. *Insert appropriate speed in knots (e.g. 6).
5. **Distance to bridge may be varied as required.
6. Maritime Safety Queensland shall decide appropriate sign sizes according to the character of the waterway.

Colour Legend

- Retroreflective white
- Retroreflective red
- Black

Queensland Government			REGULATORY SIGN "MARINE SPEED LIMIT WITHIN ...m OF BRIDGE"		
Maritime Safety Queensland			Approved as a Marine Sign 		MS1008_6
Designed TV 07/13	Checked PK 07/13	Scale Not to Scale	General Manager Maritime Safety Queensland	01/02/14 Date	Page 6 of 8 A

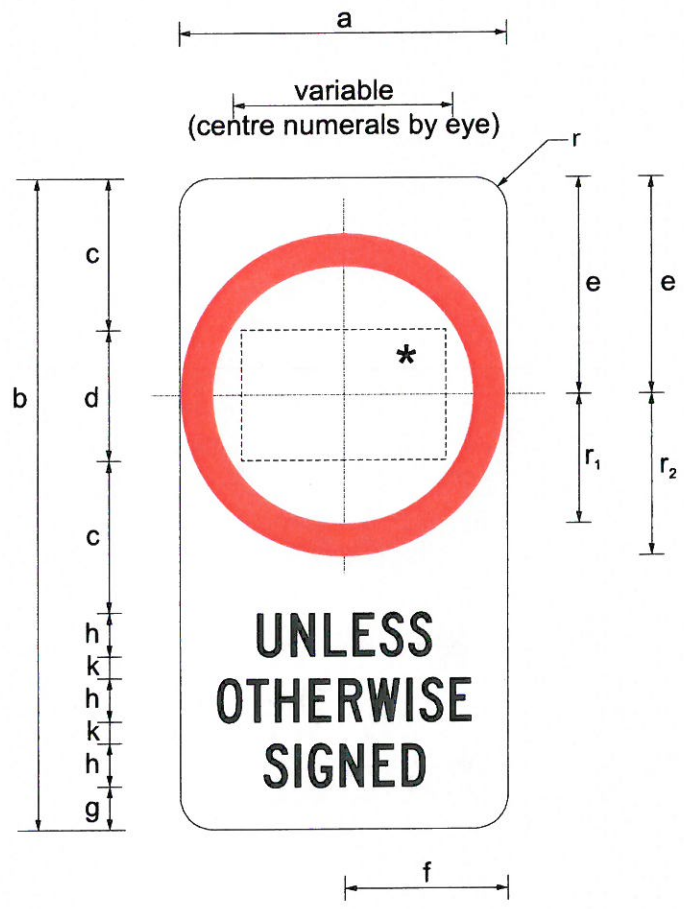

Example

	a	b	c	d (1 numeral)	d (2 numerals)	e	f	g	h	k	r	r ₁	r ₂
SIZE A	450	600	210	200DN	180DN	300	225	60	60DN	30	45	178	223
SIZE B	600	800	280	260DN	240DN	400	300	300	80DN	40	60	237	297
SIZE C	900	1200	420	400DN	360DN	600	450	450	120DN	60	90	356	446
SIZE D	1200	1600	560	520DN	480DN	800	600	600	160DN	80	120	474	594

Notes

1. This sign is an official traffic sign for a fixed marine speed limit under section 206A of the *Transport Operations (Marine Safety) Act 1994*.
2. The sign may be used on waterways to limit the speed of vessels, unless otherwise signed.
3. The sign may only be erected at locations approved by Maritime Safety Queensland within the Department of Transport and Main Roads. Contact the nearest regional office of Maritime Safety Queensland for the approval process.
4. *Insert appropriate speed in knots (e.g. 40).
5. Maritime Safety Queensland shall decide appropriate sign sizes according to the character of the waterway.

Colour Legend

- Retroreflective white
- Retroreflective red
- Black

Queensland Government			REGULATORY SIGN "MARINE SPEED LIMIT UNLESS OTHERWISE SIGNED"		
Maritime Safety Queensland			Approved as a Marine Sign		MS1008_7 Page 7 of 8 A
Designed TV 07/13	Checked PK 07/13	Scale Not to Scale	General Manager Maritime Safety Queensland		
			01/02/14 Date		