

Example

	a	b	c	d (1 numeral)	d (2 numerals)	e	f	g	h	k	m	r	r <sub>1</sub>	r <sub>2</sub>
SIZE A	450	600	210	200DN	180DN	300	225	60	60CM	30	40LC	45	178	223
SIZE B	600	800	280	260DN	240DN	400	300	300	80CM	40	55LC	60	237	297
SIZE C	900	1200	420	400DN	360DN	600	450	450	120CM	60	80LC	90	356	446
SIZE D	1200	1600	560	520DN	480DN	800	600	600	160CM	80	110LC	120	474	594

**Notes**

1. This sign is an official traffic sign for a fixed marine speed limit under section 206A of the *Transport Operations (Marine Safety) Act 1994*.
2. The sign may be used on waterways to limit the speed of vessels near the shore, consistent with the relevant gazette notice.
3. The sign may only be erected at locations approved by Maritime Safety Queensland within the Department of Transport and Main Roads. Contact the nearest regional office of Maritime Safety Queensland for the approval process.
4. \*Insert appropriate speed in knots (e.g. 6).
5. \*\*Distance to shore may be varied as required.
6. Maritime Safety Queensland shall decide appropriate sign sizes according to the character of the waterway.

**Colour Legend**

- Retroreflective white
- Retroreflective red
- Black

<b>Queensland Government</b>			<b>REGULATORY SIGN</b> <b>"MARINE SPEED LIMIT</b> <b>WITHIN ...m FROM SHORE"</b>		
Maritime Safety Queensland			Approved as a Marine Sign		MS1008_8
Designed TV 07/13	Checked PK 07/13	Scale Not to Scale	General Manager Maritime Safety Queensland		
			01/02/14 Date	Page 8 of 8	
			A	B	C

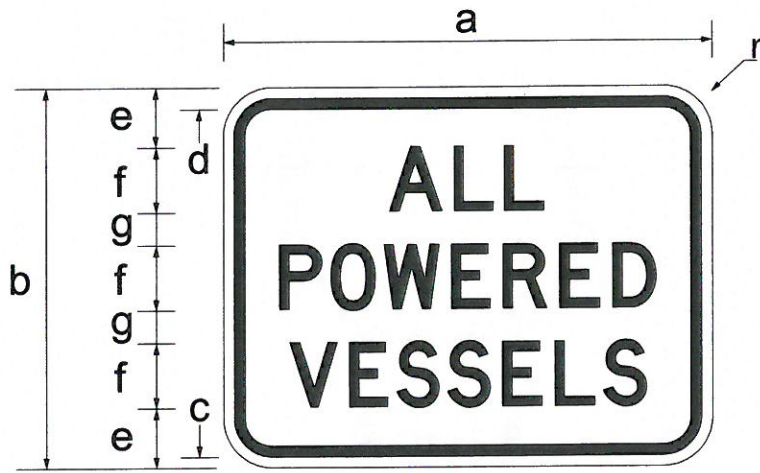

	a	b	c	d	e	f	g	r
SIZE A	450	350	10	20	55	60DN	30	45
SIZE B	600	500	15	30	90	80DN	40	60
SIZE C	900	700	20	40	110	120DN	60	90
SIZE D	1200	1000	30	60	180	160DN	80	120



Example use

**Notes**

1. This supplementary sign may be used with a marine speed limit sign on waterways to limit the speed of all powered vessels, consistent with the relevant gazette notice.
2. Sign size shall match the size of the marine speed limit sign.
3. A marine speed limit sign is an official traffic sign for a fixed marine speed limit under section 206A of the *Transport Operations (Marine Safety) Act 1994*.
4. The sign may only be erected at locations approved by Maritime Safety Queensland within the Department of Transport and Main Roads. Contact the nearest regional office of Maritime Safety Queensland for the approval process.
5. Maritime Safety Queensland shall decide appropriate sign sizes according to the character of the waterway.

**Colour Legend**

- Retroreflective white
- Black

<b>Queensland Government</b>			<b>SUPPLEMENTARY SIGN</b> <b>"ALL POWERED VESSELS"</b>		
Maritime Safety Queensland			Approved as a Marine Sign		<b>MS1009_1</b> Page 1 of 9
Designed TV 07/13	Checked PK 07/13	Scale Not to Scale	 General Manager Maritime Safety Queensland		
			01/02/14 Date	A	

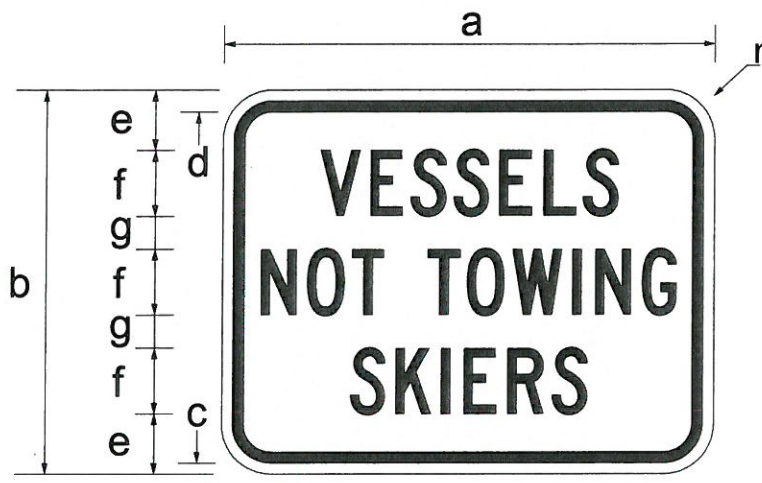

	a	b	c	d	e	f	g	r
SIZE A	450	350	10	20	55	60CN	30	45
SIZE B	600	500	15	30	90	80CN	40	60
SIZE C	900	700	20	40	110	120CN	60	90
SIZE D	1200	1000	30	60	180	160CN	80	120



Example use

**Notes**

1. This supplementary sign may be used a with marine speed limit sign on waterways to limit the speed of vessels not towing water skiers, consistent with the relevant gazette notice.
2. Sign size shall match the size of the marine speed limit sign.
3. A marine speed limit sign is an official traffic sign for a fixed marine speed limit under section 206A of the *Transport Operations (Marine Safety) Act 1994*.
4. The sign may only be erected at locations approved by Maritime Safety Queensland within the Department of Transport and Main Roads. Contact the nearest regional office of Maritime Safety Queensland for the approval process.
5. Maritime Safety Queensland shall decide appropriate sign sizes according to the character of the waterway.

**Colour Legend**

- Retroreflective white
- Black

<b>Queensland Government</b>			<b>SUPPLEMENTARY SIGN</b> <b>"VESSELS NOT TOWING SKIERS"</b>		
Maritime Safety Queensland			Approved as a Marine Sign		<b>MS1009_2</b> Page 2 of 9
Designed TV 07/13	Checked PK 07/13	Scale Not to Scale	General Manager Maritime Safety Queensland		
			01/02/14 Date	A	

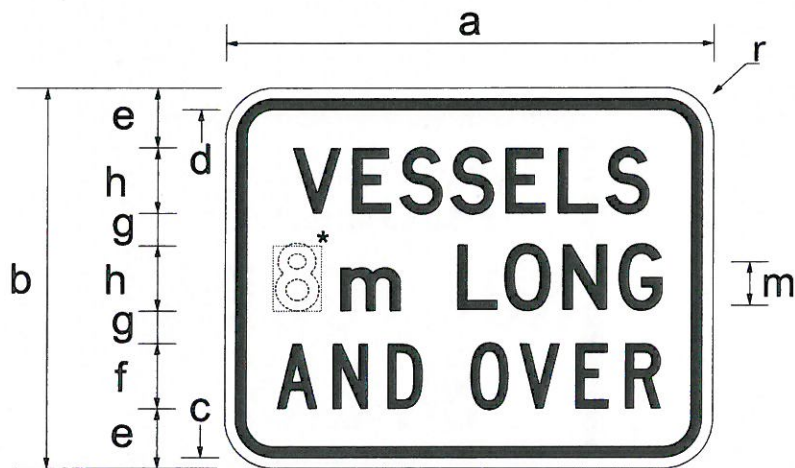

	a	b	c	d	e	f	g	h	m	r
SIZE A	450	350	10	20	55	60CM	30	60DN	40LC	45
SIZE B	600	500	15	30	90	80CM	40	80DN	55LC	60
SIZE C	900	700	20	40	110	120CM	60	120DN	80LC	90
SIZE D	1200	1000	30	60	180	160CM	80	160DN	110LC	120



Example use

**Notes**

1. This supplementary sign may be used with a marine speed limit sign on waterways to limit the speed of longer vessels, consistent with the relevant gazette notice.
2. \*Vessel length may be varied as required.
3. Sign size shall match the size of the marine speed limit sign.
4. A marine speed limit sign is an official traffic sign for a fixed marine speed limit under section 206A of the *Transport Operations (Marine Safety) Act 1994*.
5. The sign may only be erected at locations approved by Maritime Safety Queensland within the Department of Transport and Main Roads. Contact the nearest regional office of Maritime Safety Queensland for the approval process.
6. Maritime Safety Queensland shall decide appropriate sign sizes according to the character of the waterway.

**Colour Legend**

- Retroreflective white
- Black

<b>Queensland Government</b>			<b>SUPPLEMENTARY SIGN</b> <b>"VESSELS ...m LONG AND OVER"</b>		
Maritime Safety Queensland			Approved as a Marine Sign		<b>MS1009_3</b> Page 3 of 9
Designed TV 07/13	Checked PK 07/13	Scale Not to Scale	General Manager Maritime Safety Queensland		
					A <span style="border: 1px solid black; display: inline-block; width: 15px; height: 15px; vertical-align: middle;"></span> <span style="border: 1px solid black; display: inline-block; width: 15px; height: 15px; vertical-align: middle;"></span> <span style="border: 1px solid black; display: inline-block; width: 15px; height: 15px; vertical-align: middle;"></span> <span style="border: 1px solid black; display: inline-block; width: 15px; height: 15px; vertical-align: middle;"></span>

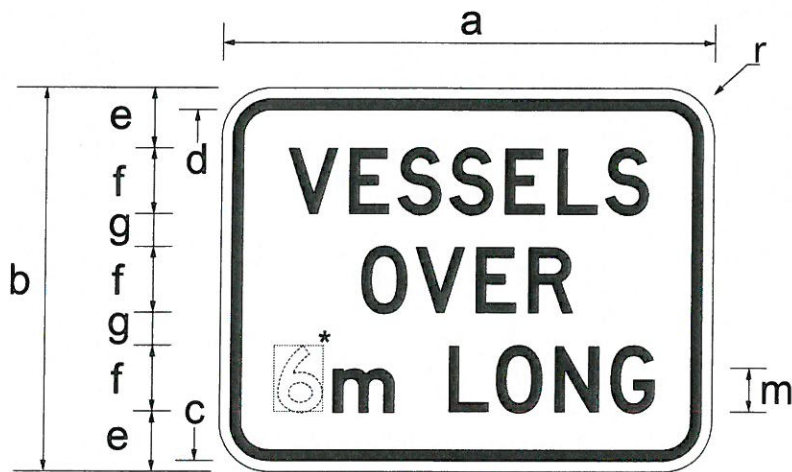

	a	b	c	d	e	f	g	m	r
SIZE A	450	350	10	20	55	60DN	30	40LC	45
SIZE B	600	500	15	30	90	80DN	40	55LC	60
SIZE C	900	700	20	40	110	120DN	60	80LC	90
SIZE D	1200	1000	30	60	180	160DN	80	110LC	120



Example use

**Notes**

1. This supplementary sign may be used with a marine speed limit sign on waterways to limit the speed of vessels over 6\* metres in length, consistent with the relevant gazette notice.
2. \*Vessel length may be varied as required.
3. Sign size shall match the size of the marine speed limit sign.
4. A marine speed limit sign is an official traffic sign for a fixed marine speed limit under section 206A of the *Transport Operations (Marine Safety) Act 1994*.
5. The sign may only be erected at locations approved by Maritime Safety Queensland within the Department of Transport and Main Roads. Contact the nearest regional office of Maritime Safety Queensland for the approval process.
6. Maritime Safety Queensland shall decide appropriate sign sizes according to the character of the waterway.

**Colour Legend**

- Retroreflective white
- Black



**Queensland Government**

**SUPPLEMENTARY SIGN**  
"VESSELS OVER ...m LONG"

Maritime Safety Queensland

Approved as a Marine Sign

General Manager  
Maritime Safety Queensland

01/02/14  
Date

MS1009\_4

Page 4 of 9

Designed  
TV 07/13

Checked  
PK 07/13

Scale  
Not to Scale

A			
---	--	--	--



	a	b	c	d	e	f	g	h	m	r
SIZE A	450	350	10	20	55	60CM	30	60DN	40LC	45
SIZE B	600	500	15	30	90	80CM	40	80DN	55LC	60
SIZE C	900	700	20	40	110	120CM	60	120DN	80LC	90
SIZE D	1200	1000	30	60	180	160CM	80	160DN	110LC	120



Example use

**Notes**

1. This supplementary sign may be used with a marine speed limit sign on waterways to limit the speed of vessels with a draft of 3\* metres and over, consistent with the relevant gazette notice.
2. \*Draft may be varied as required.
3. Sign size shall match the size of the marine speed limit sign.
4. A marine speed limit sign is an official traffic sign for a fixed marine speed limit under section 206A of the *Transport Operations (Marine Safety) Act 1994*.
5. The sign may only be erected at locations approved by Maritime Safety Queensland within the Department of Transport and Main Roads. Contact the nearest regional office of Maritime Safety Queensland for the approval process.
6. Maritime Safety Queensland shall decide appropriate sign sizes according to the character of the waterway.

**Colour Legend**

- Retroreflective white
- Black



**Queensland  
Government**

**SUPPLEMENTARY SIGN**  
"VESSELS ...m DRAFT AND OVER"

Maritime Safety Queensland

Approved as a Marine Sign

*P. G. W.*

General Manager  
Maritime Safety Queensland

01/02/14  
Date

MS1009\_5

Page 5 of 9

Designed  
TV 07/13

Checked  
PK 07/13

Scale  
Not to Scale

A				
---	--	--	--	--

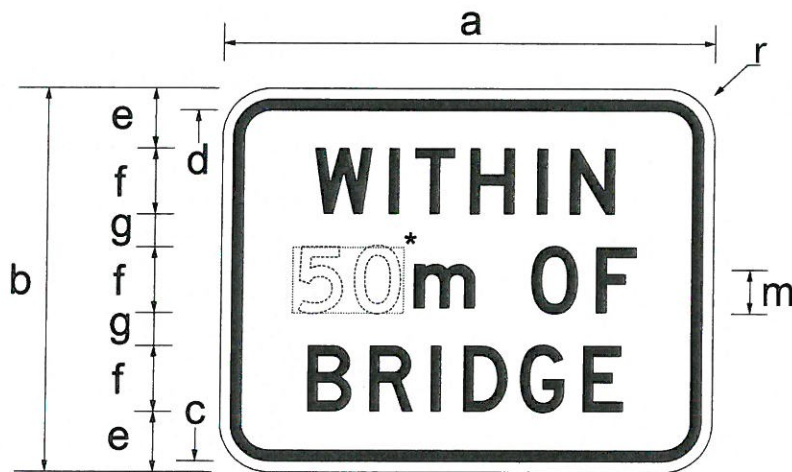

	a	b	c	d	e	f	g	m	r
SIZE A	450	350	10	20	55	60DM	30	40LC	45
SIZE B	600	500	15	30	90	80DM	40	55LC	60
SIZE C	900	700	20	40	110	120DM	60	80LC	90
SIZE D	1200	1000	30	60	180	160DM	80	110LC	120



Example use

**Notes**

1. This supplementary sign may be used with a marine speed limit sign on waterways to limit the speed of vessels within 50\* metres of a bridge, consistent with the relevant gazette notice.
2. \*Distance to bridge may be varied as required.
3. Sign size shall match the size of the marine speed limit sign.
4. A marine speed limit sign is an official traffic sign for a fixed marine speed limit under section 206A of the *Transport Operations (Marine Safety) Act 1994*.
5. The sign may only be erected at locations approved by Maritime Safety Queensland within the Department of Transport and Main Roads. Contact the nearest regional office of Maritime Safety Queensland for the approval process.
6. Maritime Safety Queensland shall decide appropriate sign sizes according to the character of the waterway.

**Colour Legend**

- Retroreflective white
- Black

<b>Queensland Government</b>			<b>SUPPLEMENTARY SIGN</b> "WITHIN ...m OF BRIDGE"		
Maritime Safety Queensland			Approved as a Marine Sign		MS1009_6 Page 6 of 9
Designed TV 07/13	Checked PK 07/13	Scale Not to Scale	General Manager Maritime Safety Queensland		
			A		



	a	b	c	d	e	f	g	r
SIZE A	450	350	10	20	55	60CN	30	45
SIZE B	600	500	15	30	90	80CN	40	60
SIZE C	900	700	20	40	110	120CN	60	90
SIZE D	1200	1000	30	60	180	160CN	80	120



Example use

**Notes**

1. This supplementary sign may be used with a marine speed limit sign on waterways to limit the speed of vessels, unless otherwise signed.
2. Sign size shall match the size of the marine speed limit sign.
3. A marine speed limit sign is an official traffic sign for a fixed marine speed limit under section 206A of the *Transport Operations (Marine Safety) Act 1994*.
4. The sign may only be erected at locations approved by Maritime Safety Queensland within the Department of Transport and Main Roads. Contact the nearest regional office of Maritime Safety Queensland for the approval process.
5. Maritime Safety Queensland shall decide appropriate sign sizes according to the character of the waterway.

**Colour Legend**

- Retroreflective white
- Black

<b>Queensland Government</b>			<b>SUPPLEMENTARY SIGN</b> <b>"UNLESS OTHERWISE SIGNED"</b>		
Maritime Safety Queensland			Approved as a Marine Sign		MS1009_7 Page 7 of 9
Designed TV 07/13	Checked PK 07/13	Scale Not to Scale	General Manager Maritime Safety Queensland		
			01/02/14 Date	A	

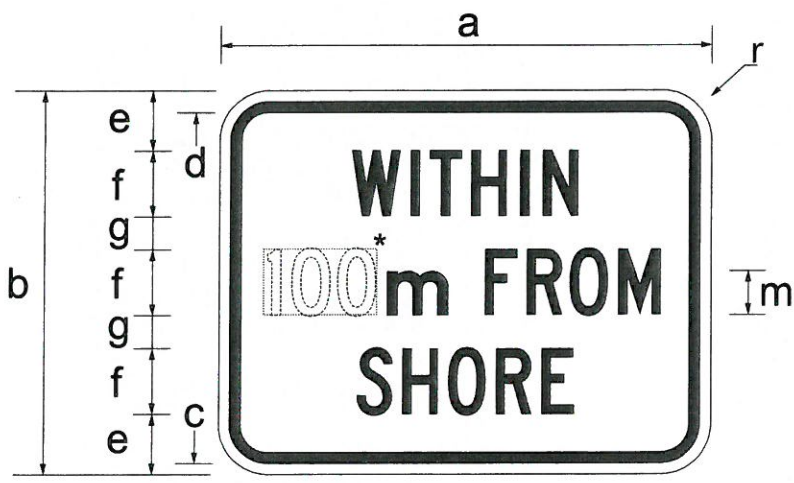

	a	b	c	d	e	f	g	k	r
SIZE A	450	350	10	20	55	60CN	30	50	45
SIZE B	600	500	15	30	90	80CN	40	90	60
SIZE C	900	700	20	40	110	120CN	60	90	90
SIZE D	1200	1000	30	60	180	160CN	80	120	120



Example use

**Notes**

1. This supplementary sign may be used with a marine speed limit sign on waterways to limit the speed of vessels near the shore, consistent with the relevant gazette notice.
2. Sign size shall match the size of the marine speed limit sign.
3. \*Distance to shore may be varied as required by gazette notice.
4. A marine speed limit sign is an official traffic sign for a fixed marine speed limit under section 206A of the *Transport Operations (Marine Safety) Act 1994*.
5. The sign may only be erected at locations approved by Maritime Safety Queensland within the Department of Transport and Main Roads. Contact the nearest regional office of Maritime Safety Queensland for the approval process.
6. Maritime Safety Queensland shall decide appropriate sign sizes according to the character of the waterway.

**Colour Legend**

- Retroreflective white
- Black

<b>Queensland Government</b>			<b>SUPPLEMENTARY SIGN</b> "WITHIN ...m FROM SHORE"		
Maritime Safety Queensland			Approved as a Marine Sign		MS1009_8 Page 8 of 9
Designed TV 07/13	Checked PK 07/13	Scale Not to Scale	General Manager Maritime Safety Queensland		
			01/02/14 Date	A	



	a	b	c	d	e	f	g	k	r
SIZE A	450	350	10	20	55	60CN	30	50	45
SIZE B	600	500	15	30	90	80CN	40	90	60
SIZE C	900	700	20	40	110	120CN	60	90	90
SIZE D	1200	1000	30	60	180	160CN	80	120	120



Example use

**Colour Legend**

- Retroreflective white
- Black

**Notes**

1. This supplementary sign may be used with a marine speed limit sign to inform waterway users of the operational speed limit for wash under section 128 of the *Transport Operations (Marine Safety) Regulation 2004*.
2. The size of the supplementary sign shall match the size of the marine speed limit sign.
4. A marine speed limit sign is an official traffic sign for a fixed marine speed limit under section 206A of the *Transport Operations (Marine Safety) Act 1994*.
5. The sign may only be erected at locations approved by Maritime Safety Queensland within the Department of Transport and Main Roads. Contact the nearest regional office of Maritime Safety Queensland for the approval process.
6. Maritime Safety Queensland shall decide appropriate sign sizes according to the character of the waterway.

<b>Queensland Government</b>			<b>SUPPLEMENTARY SIGN</b> <b>"REDUCE WASH"</b>		
Maritime Safety Queensland			Approved as a Marine Sign		<b>MS1009_9</b> Page 9 of 9
Designed TV 07/13	Checked PK 07/13	Scale Not to Scale	General Manager Maritime Safety Queensland		
			A		

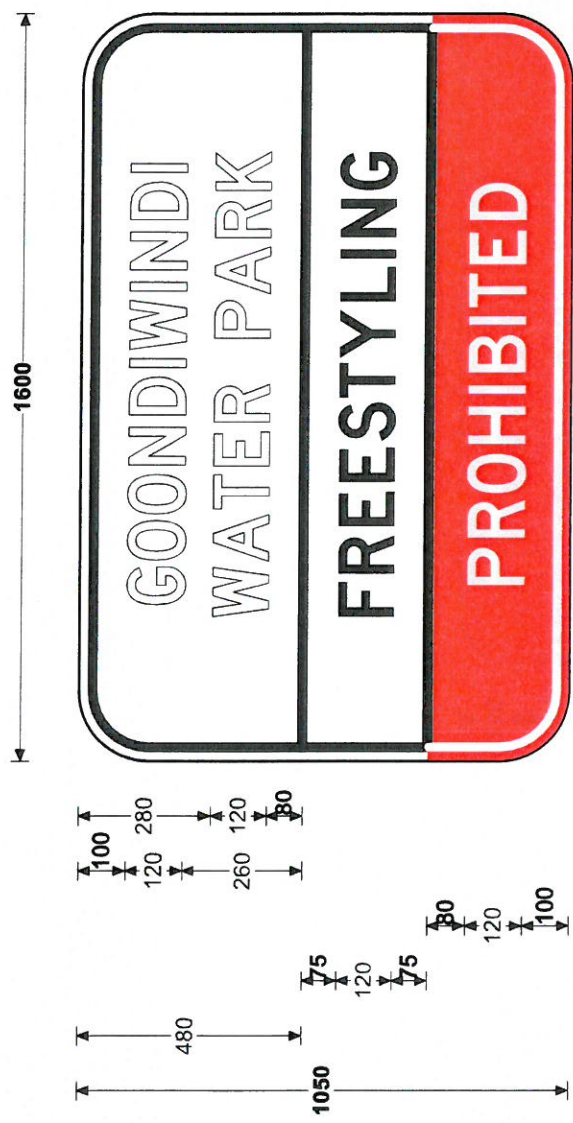

Example \*

**Colour Legend**

- Retroreflective white
- Retroreflective red
- Black

**Notes:**

1. This sign shall be used to inform vessel masters of a freestyling prohibition under section 221(3) of the *Transport Operations (Marine Safety) Regulation 2004*, according to the relevant gazette notice.
2. \*The variable text shall be populated with the name of the location.
3. The sign may only be erected at locations approved by Maritime Safety Queensland within the Department of Transport and Main Roads. Contact the nearest regional office of Maritime Safety Queensland for the approval process.
3. The sign may be erected near public boat ramps.

 <b>Queensland Government</b>	Maritime Safety Queensland	Approved as a Marine Sign  General Manager Maritime Safety Queensland		REGULATORY SIGN (WITH VARIABLE TEXT) "FREESTYLING PROHIBITED"	MS1025
	Checked PK 02/2014	Scale Not to Scale	Date 05/03/2014	A	A

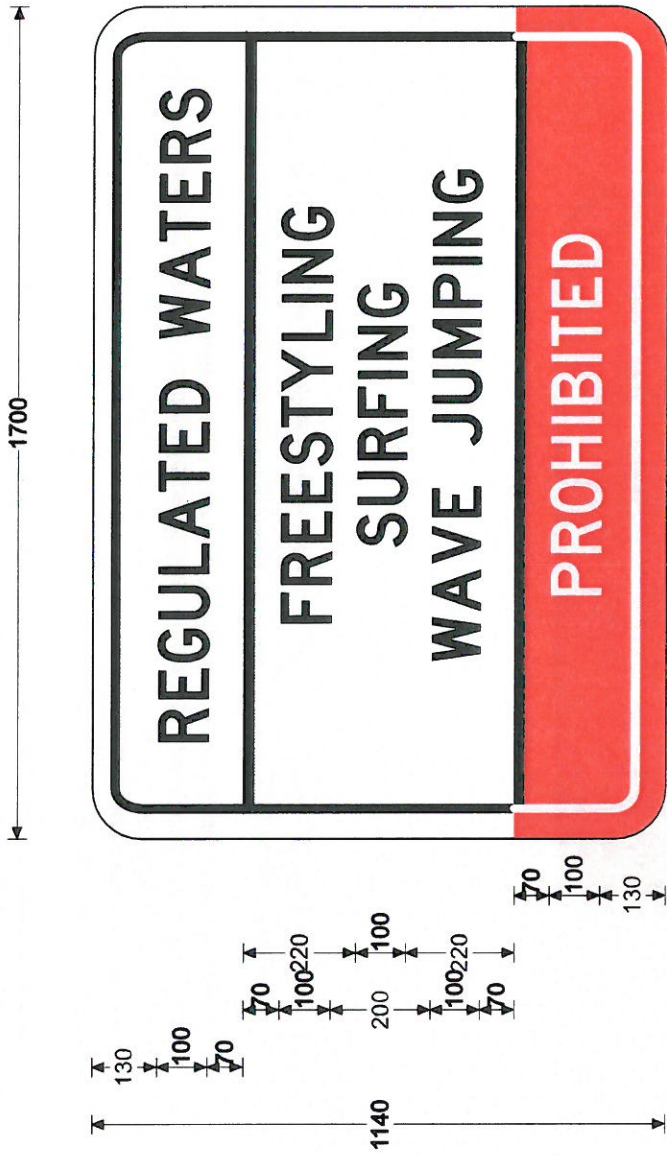



**Colour Legend**

- Retroreflective white
- Retroreflective red
- Black

**Notes:**

1. This sign shall be used to inform vessel masters of a prohibition for freestyling, surfing and wave jumping under section 19 of the *Transport Infrastructure (Waterways Management) Regulation 2012*.
2. The sign may only be erected at locations approved by Maritime Safety Queensland within the Department of Transport and Main Roads. Contact the nearest regional office of Maritime Safety Queensland for the approval process.
3. The sign may be erected near public boat ramps.

 <b>Queensland Government</b>	Checked PK 02/2014	Maritime Safety Queensland	Approved as a Marine Sign   General Manager Maritime Safety Queensland	05/03/2014 Date	REGULATORY SIGN  "FREESTYLING PROHIBITED"	MS1026  A <span style="border: 1px solid black; display: inline-block; width: 15px; height: 15px;"></span> <span style="border: 1px solid black; display: inline-block; width: 15px; height: 15px;"></span> <span style="border: 1px solid black; display: inline-block; width: 15px; height: 15px;"></span>
	Designed LC 02/2014	Scale Not to Scale				

## WARNING SIGNS

61

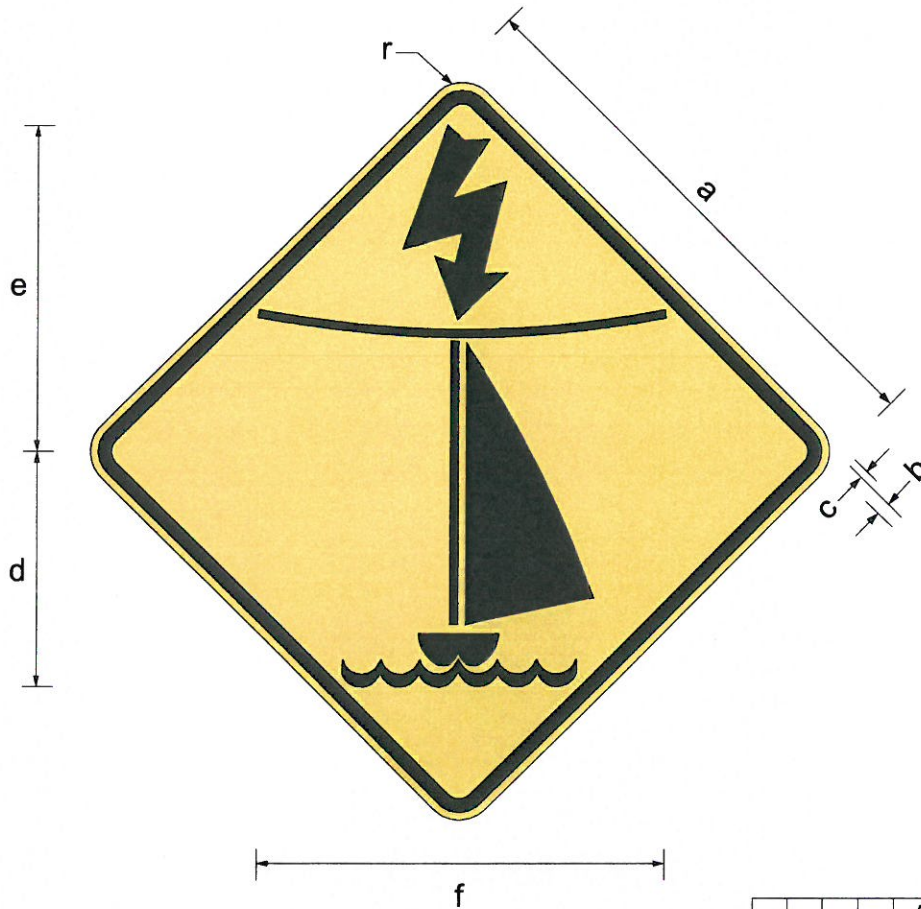

	a	b	c	d	e	f	r
SIZE A	600	16	8	26	36	45	40
SIZE B	750	20	10	33	45	56	50
SIZE C	900	24	12	49	54	68	60

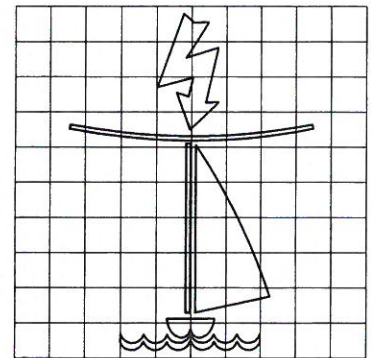

**Colour Legend**

- Retroreflective yellow
- Black

**Notes**

1. This sign may be used at locations where overhead powerlines cross a river, stream, creek or waterway.
2. Installation of the sign is the responsibility of the overhead powerline's owner.
3. Maritime Safety Queensland within Department of Transport and Main Roads may provide advice to the powerline's owner regarding the location for the sign.
4. Refer to MS1010\_2 and MS1010\_3 for application to warning signs.



**Queensland  
Government**

**WARNING SIGN**  
"OVERHEAD POWERLINE"

Maritime Safety Queensland

Approved as a Marine Sign

General Manager  
Maritime Safety Queensland

01/02/14  
Date

**MS1010\_1**

Page 1 of 4

Designed  
TV 07/13

Checked  
PK 07/13

Scale  
Not to Scale

A			
---	--	--	--

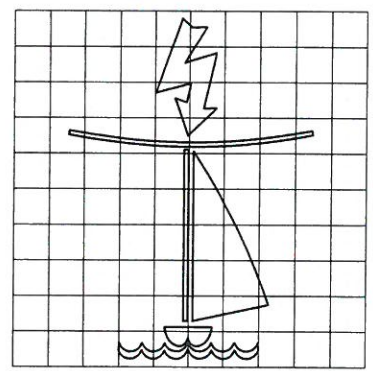
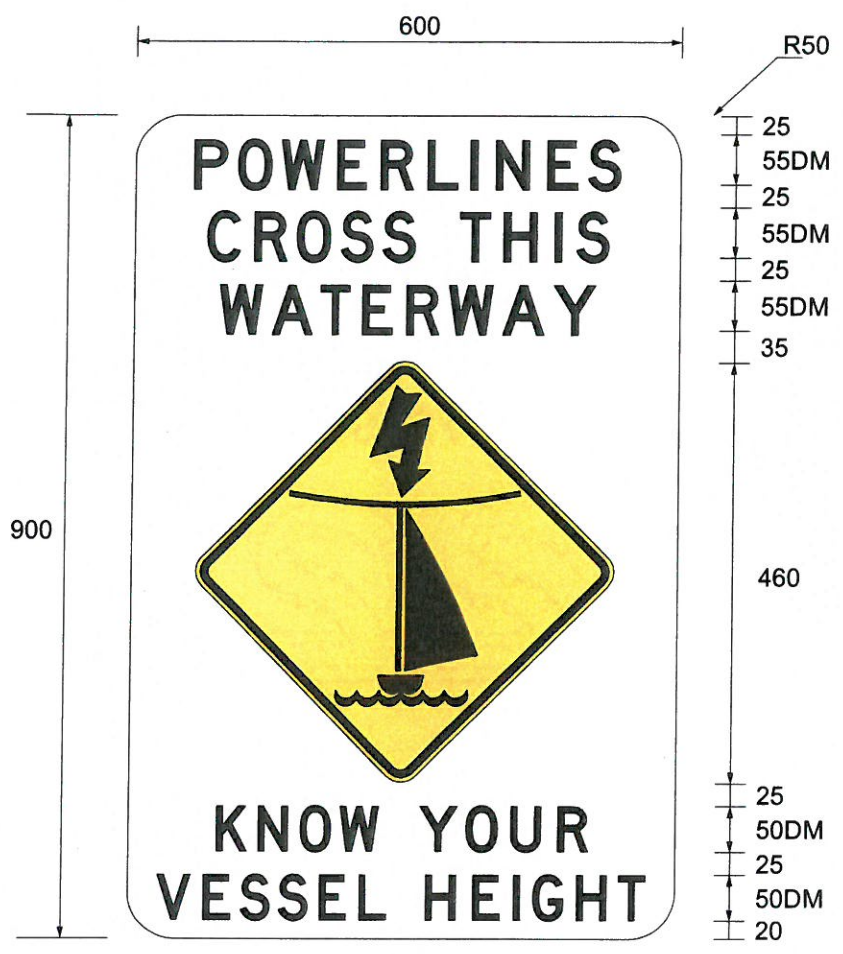

**Colour Legend**

- Retroreflective white
- Retroreflective yellow
- Black

**Notes**

1. This sign may be used at locations where overhead powerline cross a river, stream, creek or waterway.
2. Installation of the sign is the responsibility of the overhead powerline's owner.
3. Maritime Safety Queensland within Department of Transport and Main Roads may provide advice to the powerline's owner regarding the location for the sign.
4. For warning sign details refer to MS1010\_1.



**Queensland Government**

**WARNING SIGN  
OVERHEAD POWERLINE  
"KNOW YOUR VESSEL HEIGHT"**

Maritime Safety Queensland

Approved as a Marine Sign

*P. G. W.*

General Manager  
Maritime Safety Queensland

01/02/14  
Date

MS1010\_2

Page 2 of 4

Designed  
TV 07/13

Checked  
PK 07/13

Scale  
Not to Scale

A			
---	--	--	--

63

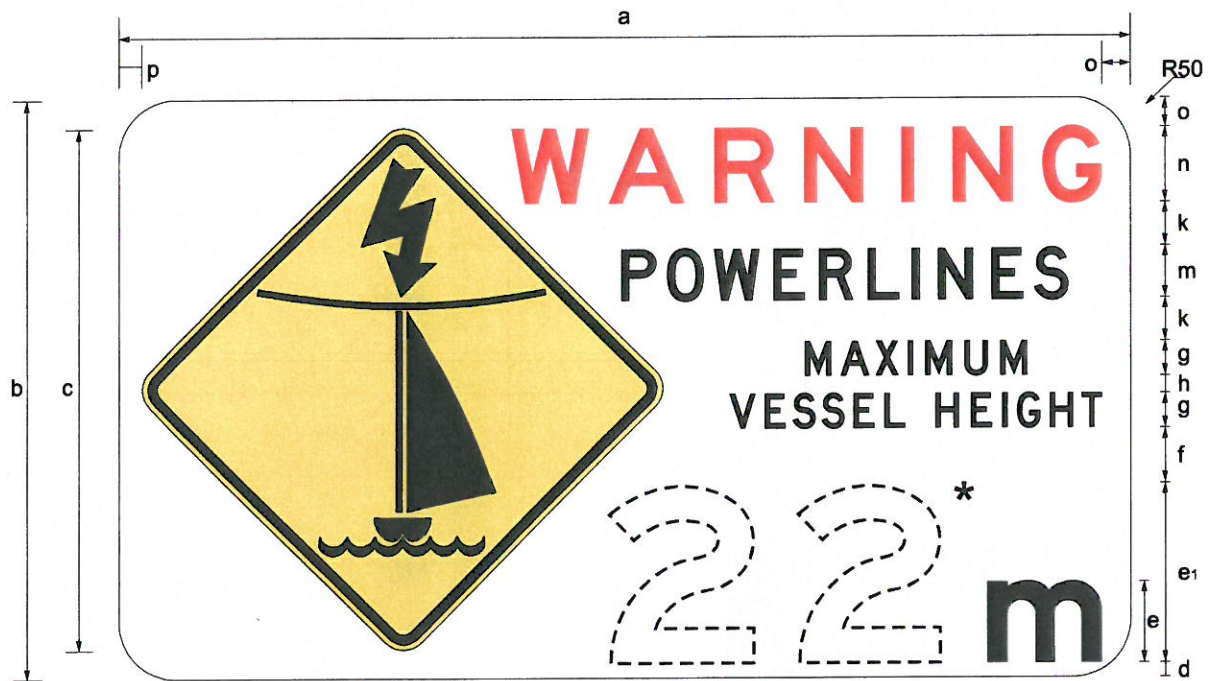

	a	b	c	d	e	e <sub>1</sub>	f	g	h	k	m	n	o	p	r
SIZE A	2800	1600	1440	40	220LC	500 Mod E	150	100DM	50	120	140DM	200EW	80	65	80
SIZE B	3500	2000	1800	50	280LC	620 Mod E	190	120DM	60	150	180 DM	260EW	100	100	100

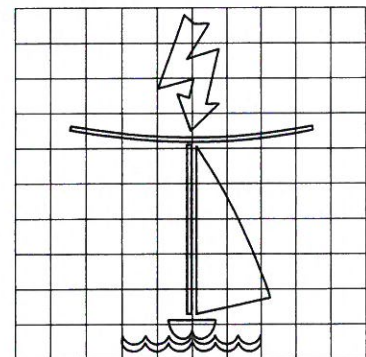

**Colour Legend**

- Retroreflective white
- Retroreflective yellow
- Retroreflective red
- Black

**Notes**

1. This sign may be used at locations where overhead powerline cross a river, stream, creek or waterway.
2. Installation of the sign is the responsibility of the overhead powerline's owner.
3. Maritime Safety Queensland within Department of Transport and Main Roads may provide advice to the powerline's owner regarding the location for the sign.
4. For warning sign details refer to MS1010\_1.
5. \* Insert appropriate height in metres (e.g. 22).
6. For supplementary flooding sign refer to MS1010\_4.



**Queensland Government**

**WARNING SIGN  
"OVERHEAD POWERLINE"**

Maritime Safety Queensland

Approved as a Marine Sign

*P. G. W.*

General Manager  
Maritime Safety Queensland

01/02/14  
Date

**MS1010\_3**

Page 3 of 4

Designed  
TV 07/13

Checked  
PK 07/13

Scale  
Not to Scale

A			
---	--	--	--

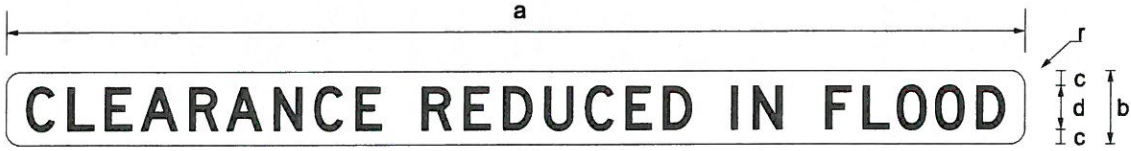

	a	b	c	d	r
SIZE A	2800	200	40	120DM	50
SIZE B	3500	250	50	150DM	50

**Colour Legend**

- Retroreflective white
- Black

**Notes**

1. This sign may be used as a supplementary sign to warning sign MS1010\_3, to highlight reduced clearances in flooding, at locations where overhead powerlines cross a river, stream, creek or waterway.
2. Installation of the sign is the responsibility of the overhead powerline's owner.
3. Maritime Safety Queensland within Department of Transport and Main Roads may provide advice to the powerline's owner regarding the location for the sign.

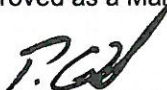
 <b>Queensland Government</b>			<b>SUPPLEMENTARY SIGN</b> <b>"CLEARANCE REDUCED IN FLOOD"</b>		
Maritime Safety Queensland			Approved as a Marine Sign  _____		<b>MS1010_4</b>
Designed TV 07/13	Checked PK 07/13	Scale Not to Scale	General Manager Maritime Safety Queensland	01/02/14 Date	Page 4 of 4 A <input type="checkbox"/> <input type="checkbox"/> <input type="checkbox"/> <input type="checkbox"/>

65

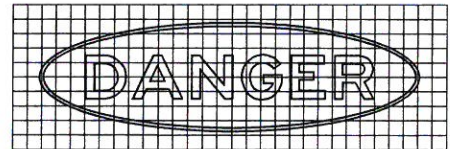

**Colour Legend**

- Retroreflective white
- Retroreflective red
- Black

**Notes**

1. This sign may be used at locations where overhead powerlines cross a river, stream, creek or waterway.
2. Installation of the sign is the responsibility of the overhead powerline's owner.
3. Maritime Safety Queensland within Department of Transport and Main Roads may provide advice to the powerline's owner regarding the location for the sign.
4. For option with clearance height refer to MS1011\_2.



**Queensland  
Government**

**WARNING SIGN**  
"DANGER - OVERHEAD POWER LINE"

Maritime Safety Queensland

Approved as a Marine Sign

*P. G. W.*

**MS1011\_1**

Designed  
TV 07/13

Checked  
PK 7/13

Scale  
Not to Scale

General Manager  
Maritime Safety Queensland

01/02/14  
Date

Page 1 of 2

A

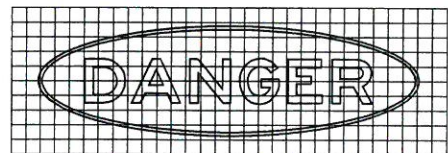

**Colour Legend**

- Retroreflective white
- Retroreflective red
- Black

**Notes**

1. This sign may be used at locations where overhead powerlines cross a river, stream, creek or waterway.
2. Installation of the sign is the responsibility of the overhead powerline's owner.
3. Maritime Safety Queensland within Department of Transport and Main Roads may provide advice to the powerline's owner regarding the location for the sign.
4. \* Insert appropriate clearance height in metres (e.g. 15.5).
5. For option without clearance height refer to MS1011\_1.



**Queensland  
Government**

**WARNING SIGN**  
"DANGER - OVERHEAD POWERLINE  
CLEARANCE ... m"

Maritime Safety Queensland

Approved as a Marine Sign

General Manager  
Maritime Safety Queensland

01/02/14  
Date

**MS1011\_2**

Page 2 of 2

Designed  
TV 07/13

Checked  
PK 7/13

Scale  
Not to Scale

A			
---	--	--	--

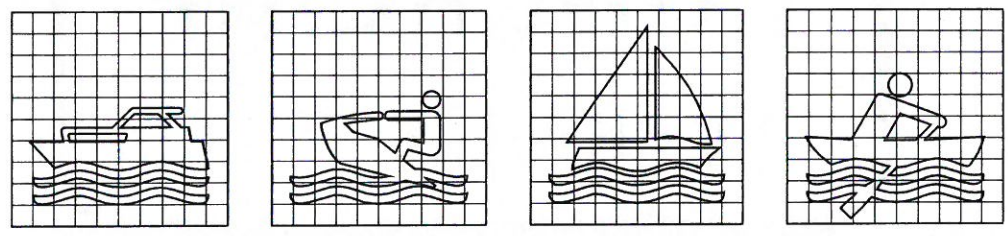

	a	b	c	d	e	f	g	h	j	k	r
SIZE A	900	600	10	20	70	60DN	110	80	140	60	50
SIZE B	1500	1100	16	32	120	100DN	240	120	240	100	75

**Colour Legend**

- Retroreflective yellow
- Black

**Notes**

1. This sign warns waterway users that different types of vessels operate on the busy waterway.
2. The sign may only be erected at locations approved by Maritime Safety Queensland within the Department of Transport and Main Roads. Contact the nearest regional office of Maritime Safety Queensland for the approval process.
3. Maritime Safety Queensland shall decide appropriate sign sizes according to the character of the waterway.
4. For five (5) symbol sign option refer to MS1012\_2.

<b>Queensland Government</b>			<b>WARNING SIGN</b> "BUSY WATERWAY (4 symbols) NAVIGATE SAFELY"		
Maritime Safety Queensland			Approved as a Marine Sign 		<b>MS1012_1</b>
Designed TV 07/13	Checked PK 07/13	Scale Not to Scale	General Manager Maritime Safety Queensland		01/02/14 Date
					Page 1 of 2 A <span style="display: inline-block; width: 15px; height: 15px; border: 1px solid black; margin: 0 5px;"></span>

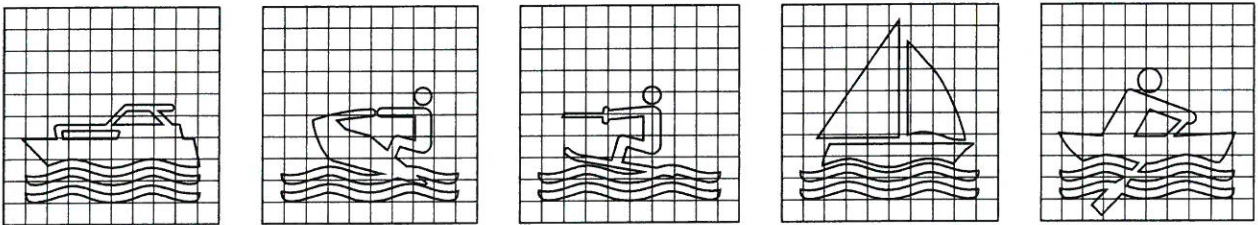
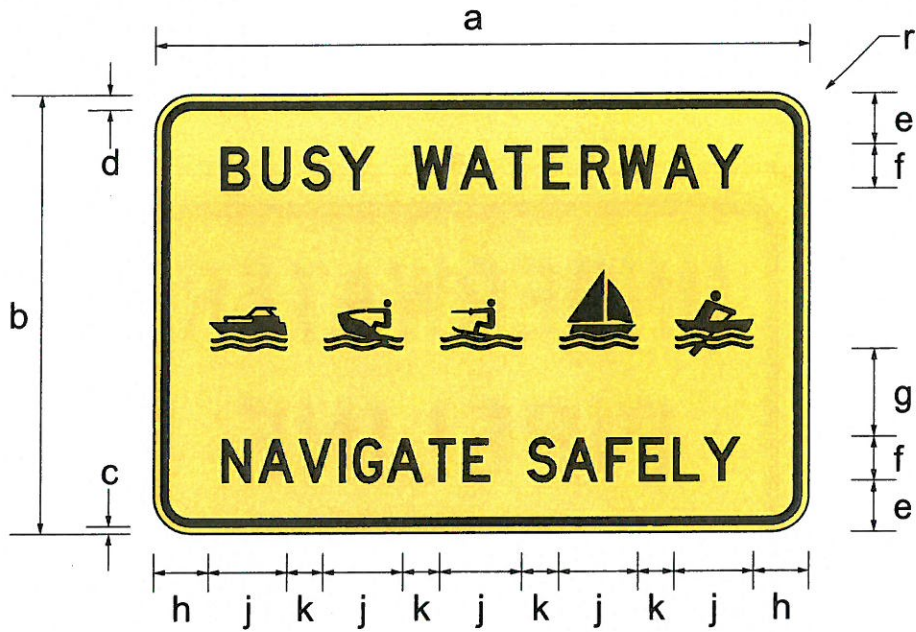

	a	b	c	d	e	f	g	h	j	k	r
SIZE A	900	600	10	20	70	60DN	120	75	110	50	50
SIZE B	1500	1100	16	32	120	100DN	250	90	200	80	75

**Colour Legend**

- Retroreflective yellow
- Black

**Notes**

1. This sign warns waterway users that different types of vessels operate on the busy waterway.
2. The sign may only be erected at locations approved by Maritime Safety Queensland within the Department of Transport and Main Roads. Contact the nearest regional office of Maritime Safety Queensland for the approval process.
3. Maritime Safety Queensland shall decide appropriate sign sizes according to the character of the waterway.
4. For four (4) symbol sign option refer to MS1012\_1.



**Queensland Government**

**WARNING SIGN**  
 "BUSY WATERWAY (5 symbols)  
 NAVIGATE SAFELY"

Maritime Safety Queensland

Approved as a Marine Sign

General Manager  
 Maritime Safety Queensland

01/02/14  
 Date

MS1012\_2

Page 2 of 2

Designed  
 TV 07/13

Checked  
 PK 07/13

Scale  
 Not to Scale

A			
---	--	--	--

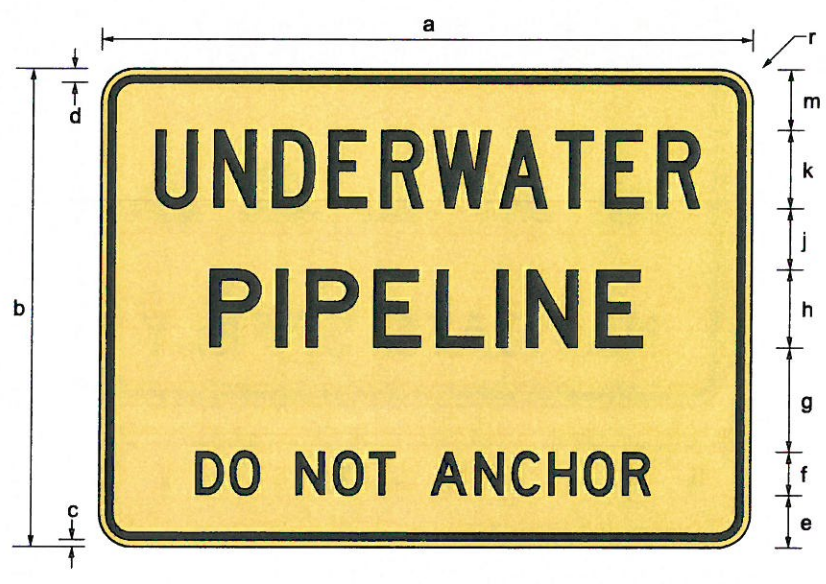

	a	b	c	d	e	f	g	h	j	k	m	r
SIZE A	900	600	10	20	70	60DN	100	100DN	80	100CN	90	50
SIZE B	1500	1100	16	32	120	100DN	240	180DN	140	180CN	140	75

**Colour Legend**

- Retroreflective yellow
- Black

**Notes**

1. This sign should be erected for underwater pipelines to warn vessel masters about these pipelines and the anchoring prohibition.
2. The sign is envisaged by section 219(1)(b) of the *Transport Operations (Marine Safety) Regulation 2004*, which deals with anchoring in particular places.
3. Installation of the sign is the responsibility of the underwater pipeline's owner.
4. Maritime Safety Queensland within the Department of Transport and Main Roads may provide advice to the pipeline's owner regarding the location and appropriate size for the sign.

<b>Queensland Government</b>			<b>WARNING SIGN</b> "UNDERWATER PIPELINE DO NOT ANCHOR"		
Maritime Safety Queensland			Approved as a Marine Sign		MS1013
Designed TV 07/13	Checked PK 07/13	Scale Not to Scale	General Manager Maritime Safety Queensland		
					A

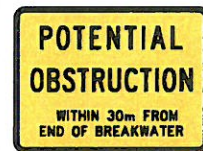
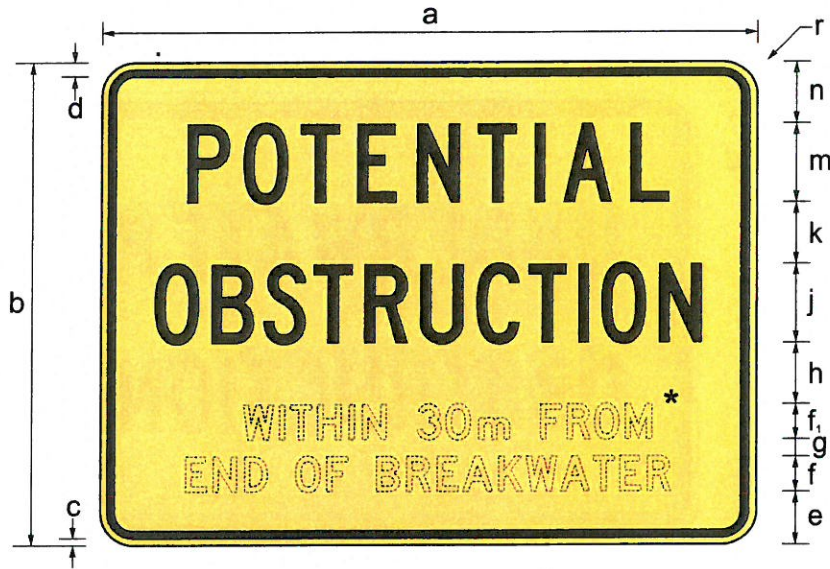

Example

	a	b	c	d	e	f	f <sub>1</sub>	g	h	j	k	m	n	r
SIZE A	900	600	10	20	70	50DN	50DN/30LC	25	65	100CN	50	100CM	90	50
SIZE B	1500	1100	16	32	120	80DN	80DN/50LC	40	140	180CN	140	180CM	140	75

**Colour Legend**

- Retroreflective yellow
- Black

**Notes**

1. This sign should be used to warn vessel masters of a specific potential obstruction within a waterway.
2. \*The variable text field shall be populated according to the character or location of the obstruction.
3. The sign may only be erected at locations approved by Maritime Safety Queensland within the Department of Transport and Main Roads. Contact the nearest regional office of Maritime Safety Queensland for the approval process.
4. Maritime Safety Queensland shall decide appropriate sign sizes according to the character of the waterway.



**Queensland Government**

**WARNING SIGN**  
**"POTENTIAL OBSTRUCTION"**  
 (WITH VARIABLE TEXT)

Maritime Safety Queensland

Approved as a Marine Sign

General Manager  
 Maritime Safety Queensland

01/02/14  
 Date

MS1014

Designed  
 TV 07/13

Checked  
 PK 07/13

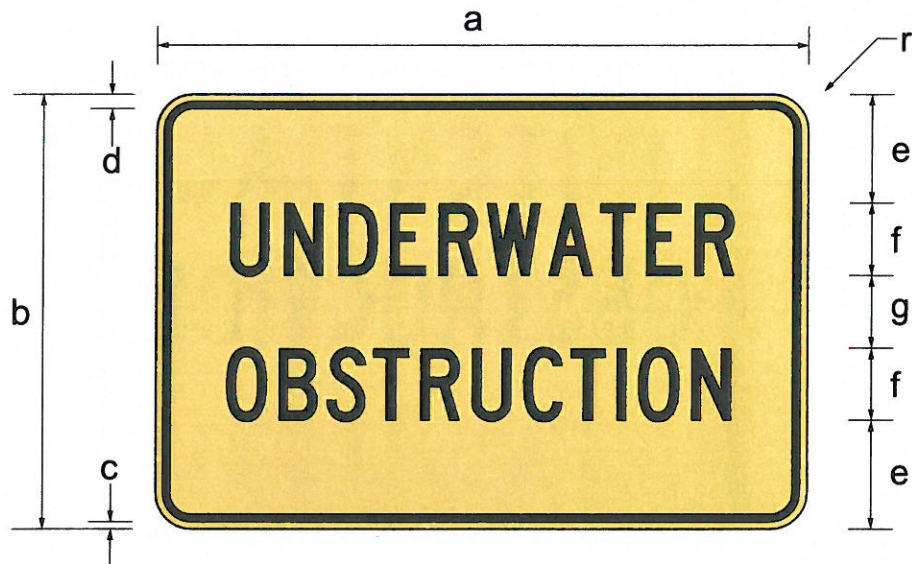

Scale  
 Not to Scale

A				
---	--	--	--	--



	a	b	c	d	e	f	g	r
SIZE A	900	600	10	20	150	100CN	100	50
SIZE B	1500	1100	16	32	280	180CN	180	75

**Colour Legend**

-  Retroreflective yellow
-  Black

**Notes**

1. This sign should be used to warn vessel masters of a specific underwater obstruction within a waterway.
2. The sign may only be erected at locations approved by Maritime Safety Queensland within the Department of Transport and Main Roads. Contact the nearest regional office of Maritime Safety Queensland for the approval process.
3. Maritime Safety Queensland shall decide appropriate sign sizes according to the character of the waterway.



**Queensland  
Government**

**WARNING SIGN  
"UNDERWATER OBSTRUCTION"**

Maritime Safety Queensland

Approved as a Marine Sign

General Manager  
Maritime Safety Queensland

01/02/14  
Date

**MS1015**

Designed  
TV 07/13

Checked  
PK 07/13

Scale  
Not to Scale

A				
---	--	--	--	--

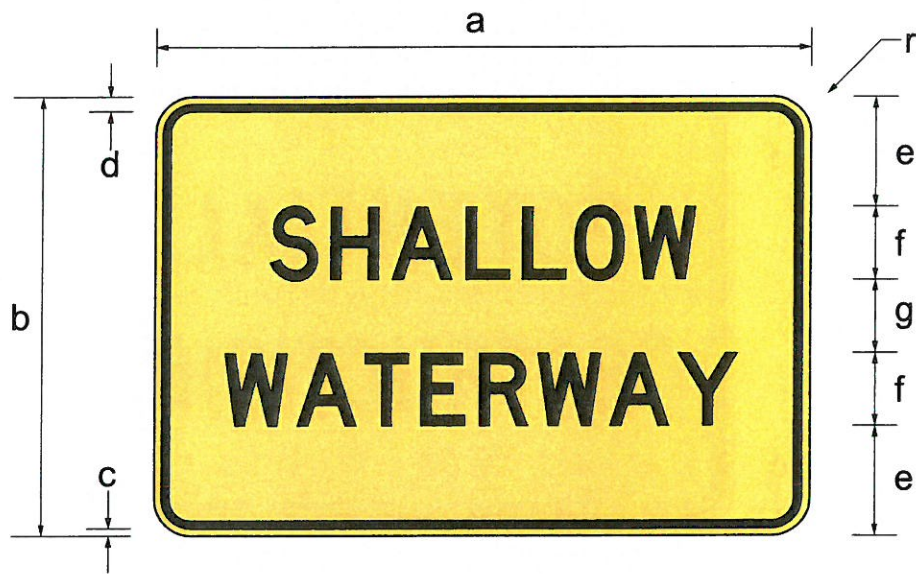

	a	b	c	d	e	f	g	r
SIZE A	900	600	10	20	150	100DN	100	50
SIZE B	1500	1100	16	32	280	180CN	180	75

**Colour Legend**

- Retroreflective yellow
- Black

**Notes**

1. This sign should be used to warn vessel masters of the shallow nature of the waterway.
2. The sign may only be erected at locations approved by Maritime Safety Queensland within the Department of Transport and Main Roads. Contact the nearest regional office of Maritime Safety Queensland for the approval process.
3. Maritime Safety Queensland shall decide appropriate sign sizes according to the character of the waterway.



**Queensland  
Government**

**WARNING SIGN  
"SHALLOW WATERWAY"**

Maritime Safety Queensland

Approved as a Marine Sign

General Manager  
Maritime Safety Queensland

01/02/14  
Date

**MS1016**

Designed  
TV 07/13

Checked  
PK 07/13

Scale  
Not to Scale

A				
---	--	--	--	--

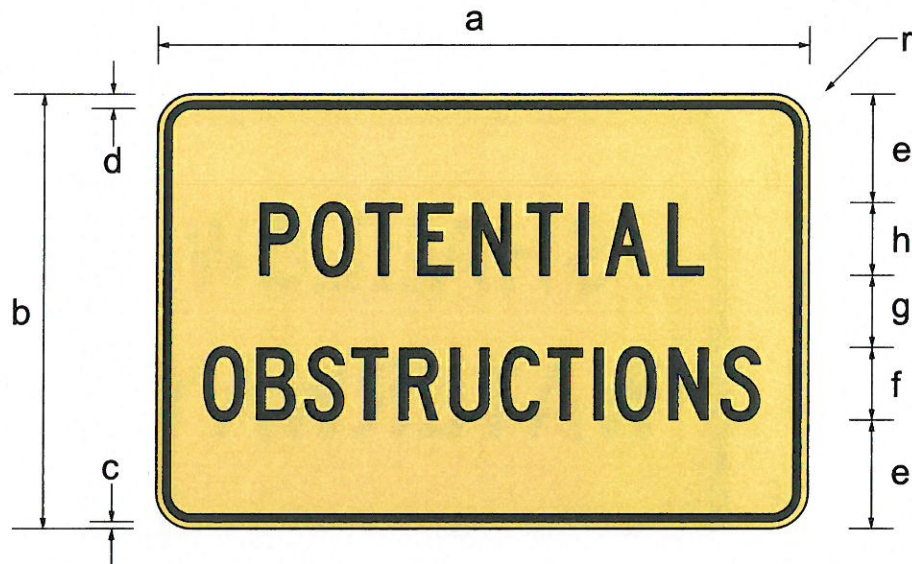

	a	b	c	d	e	f	g	h	r
SIZE A	900	600	10	20	150	100CN	100	100CM	50
SIZE B	1500	1100	16	32	280	180CN	180	180CM	75

**Colour Legend**

- Retroreflective yellow
- Black

**Notes**

1. This sign should be used to warn vessel masters that there are potential obstructions within a waterway.
2. The sign may only be erected at locations approved by Maritime Safety Queensland within the Department of Transport and Main Roads. Contact the nearest regional office of Maritime Safety Queensland for the approval process.
3. Maritime Safety Queensland shall decide appropriate sign sizes according to the character of the waterway.



**Queensland  
Government**

**WARNING SIGN  
"POTENTIAL OBSTRUCTIONS"**

Maritime Safety Queensland

Approved as a Marine Sign

*P. Co*

General Manager  
Maritime Safety Queensland

01/02/14  
Date

**MS1017**

Designed  
TV 07/13

Checked  
PK 07/13

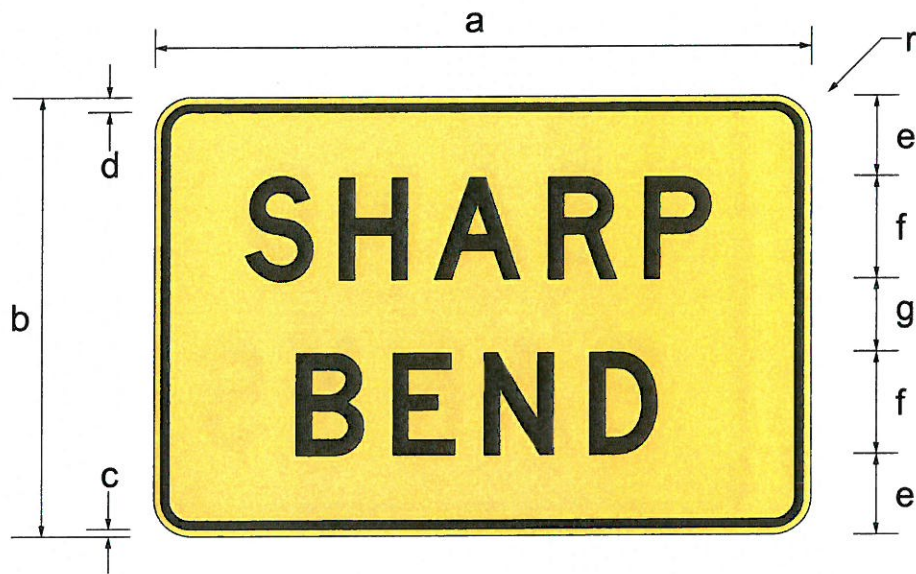

Scale  
Not to Scale

A				
---	--	--	--	--



	a	b	c	d	e	f	g	r
SIZE A	900	600	10	20	110	140DM	100	50
SIZE B	1500	1100	16	32	190	260DM	200	75

**Colour Legend**

-  Retroreflective yellow
-  Black

**Notes**

1. This sign may be used to warn vessel masters of a sharp bend within a waterway.
2. The sign may only be erected at locations approved by Maritime Safety Queensland within the Department of Transport and Main Roads. Contact the nearest regional office of Maritime Safety Queensland for the approval process.
3. Maritime Safety Queensland shall decide appropriate sign sizes according to the character of the waterway.



**Queensland  
Government**

**WARNING SIGN  
"SHARP BEND"**

Maritime Safety Queensland

Approved as a Marine Sign

General Manager  
Maritime Safety Queensland

01/02/14  
Date

**MS1018**

Designed  
TV 07/13

Checked  
PK 07/13

Scale  
Not to Scale

A				
---	--	--	--	--

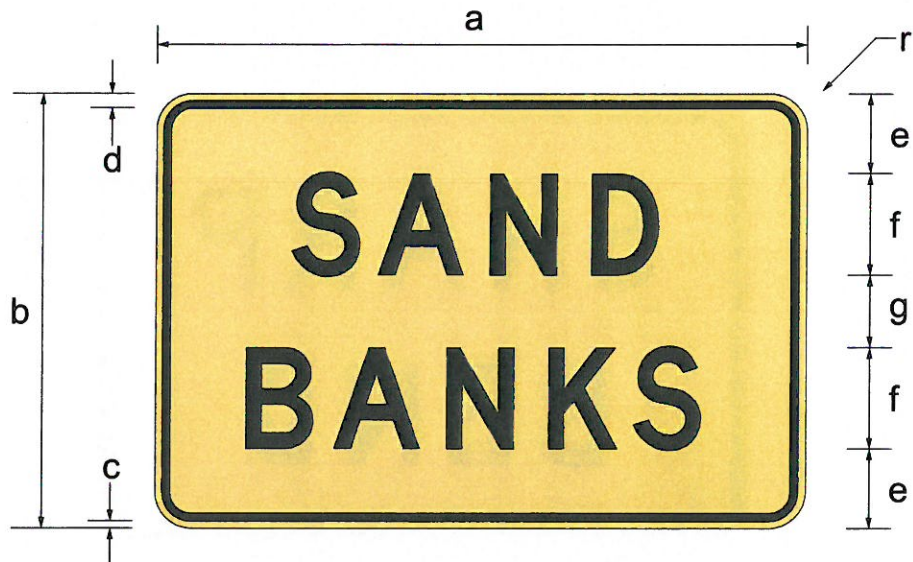

	a	b	c	d	e	f	g	r
SIZE A	900	600	10	20	110	140DM	100	50
SIZE B	1500	1100	16	32	190	260DM	200	75

**Colour Legend**

- Retroreflective yellow
- Black

**Notes**

1. This sign may be used to warn vessel masters of the sandbanks within a waterway.
2. The sign may only be erected at locations approved by Maritime Safety Queensland within the Department of Transport and Main Roads. Contact the nearest regional office of Maritime Safety Queensland for the approval process.
3. Maritime Safety Queensland shall decide appropriate sign sizes according to the character of the waterway.

<b>Queensland Government</b>			<b>WARNING SIGN</b> <b>"SAND BANKS"</b>		
Maritime Safety Queensland			Approved as a Marine Sign		MS1019
Designed TV 07/13	Checked PK 07/13	Scale Not to Scale	General Manager Maritime Safety Queensland		
					A

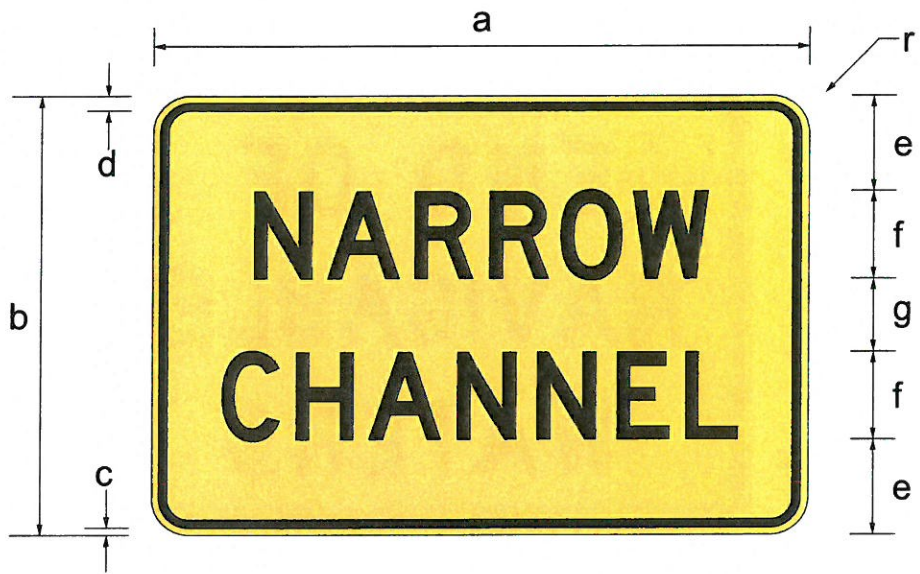

	a	b	c	d	e	f	g	r
SIZE A	900	600	10	20	130	120DN	100	50
SIZE B	1500	1100	16	32	250	200DN	200	75

**Colour Legend**

- Retroreflective yellow
- Black

**Notes**

1. This sign may be used to warn vessel masters of a narrow channel within a waterway.
2. The sign may only be erected at locations approved by Maritime Safety Queensland within the Department of Transport and Main Roads. Contact the nearest regional office of Maritime Safety Queensland for the approval process.
3. Maritime Safety Queensland shall decide appropriate sign sizes according to the character of the waterway.



**Queensland Government**

**WARNING SIGN  
"NARROW CHANNEL"**

Maritime Safety Queensland

Approved as a Marine Sign

General Manager  
Maritime Safety Queensland

01/02/14  
Date

**MS1020**

Designed  
TV 07/13

Checked  
PK 07/13

Scale  
Not to Scale

A				
---	--	--	--	--

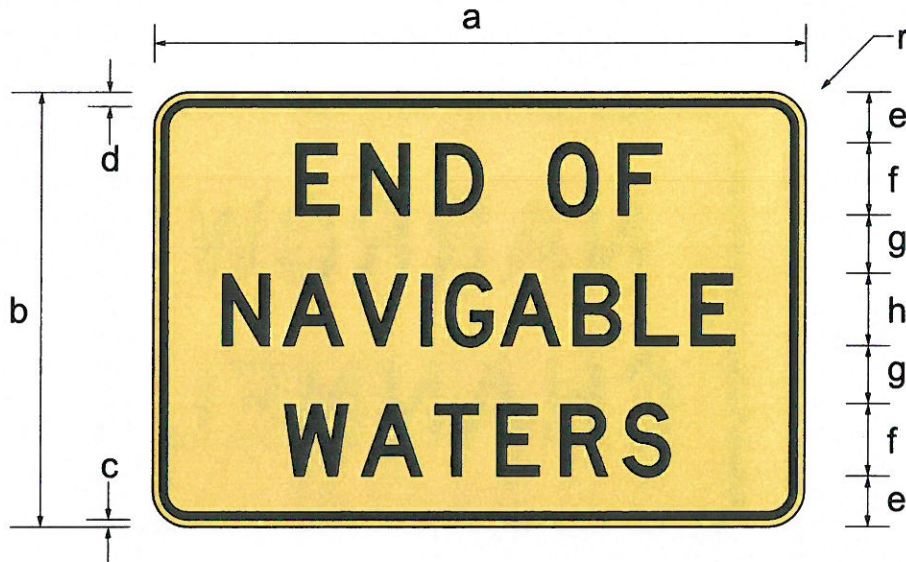

	a	b	c	d	e	f	g	h	r
SIZE A	900	600	10	20	70	100DM	80	100DN	50
SIZE B	1500	1100	16	32	140	180DM	140	180DN	75

**Colour Legend**

- Retroreflective yellow
- Black

**Notes**

1. This sign should be used to warn vessel masters of the end of navigable waters.
2. The sign may only be erected at locations approved by Maritime Safety Queensland within the Department of Transport and Main Roads. Contact the nearest regional office of Maritime Safety Queensland for the approval process.
3. Maritime Safety Queensland shall decide appropriate sign sizes according to the character of the waterway.



**Queensland  
Government**

**WARNING SIGN**  
"END OF NAVIGABLE WATERS"

Maritime Safety Queensland

Approved as a Marine Sign

General Manager  
Maritime Safety Queensland

01/02/14  
Date

MS1021

Designed  
TV 07/13

Checked  
PK 07/13

Scale  
Not to Scale

A				
---	--	--	--	--

## **INFORMATION SIGNS**



**Colour Legend**

- Retroreflective white
- Black

**Notes**

1. This sign is designed to remind vessel masters that they are about to leave smooth or partially smooth waters and to check their safety equipment.
2. The sign may only be erected at locations approved by Maritime Safety Queensland within the Department of Transport and Main Roads. Contact the nearest regional office of Maritime Safety Queensland for the approval process.
3. The sign should only be installed where contraventions of safety equipment obligations are a known compliance issue.
4. The sign should be installed within a short distance (typically 100-300 m) from the smooth or partially smooth waters limit, ideally on breakwaters to coastal bars.



**Queensland  
Government**

**INFORMATION SIGN**  
"OPEN WATER AHEAD  
CHECK YOUR SAFETY EQUIPMENT"

Maritime Safety Queensland

Approved as a Marine Sign

**MS1022**

Designed  
TV 07/13

Checked  
PK 07/13

Scale  
Not to Scale

*P. G. W.*  
General Manager  
Maritime Safety Queensland

01/02/14  
Date

A				
---	--	--	--	--

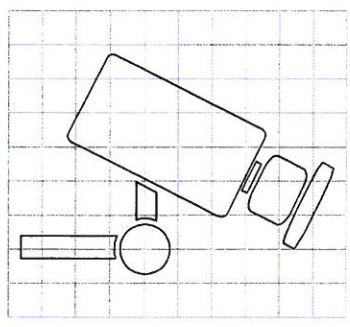
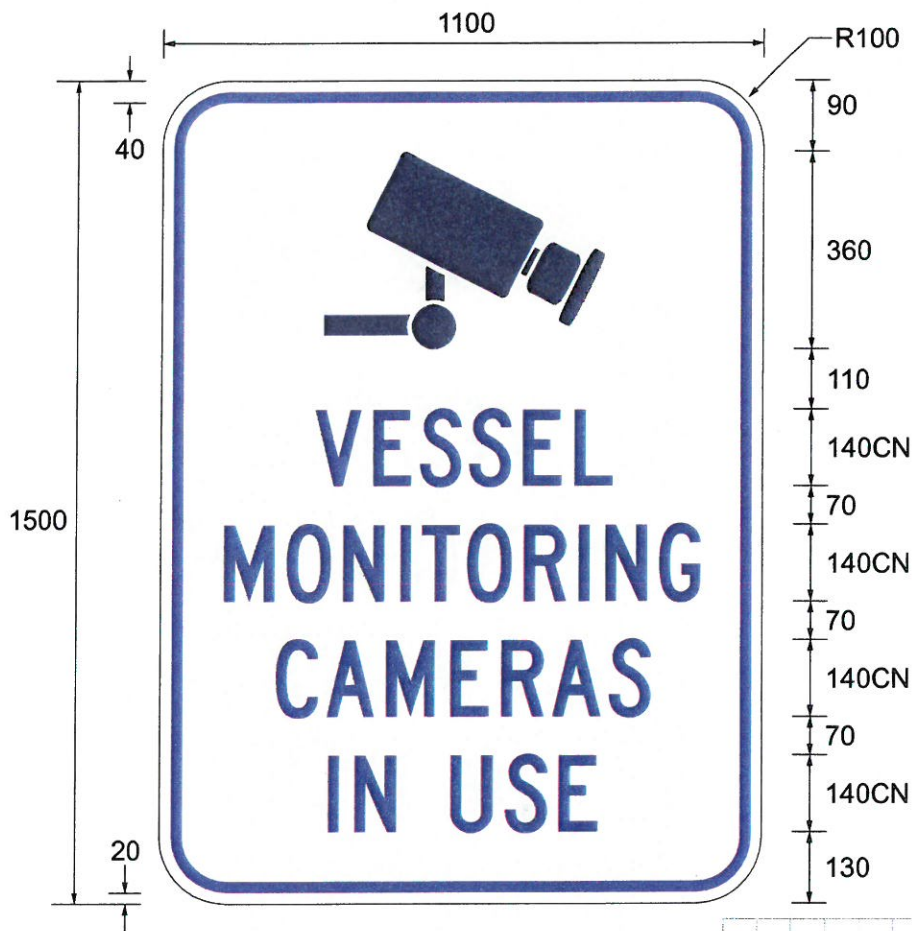

**Notes**

1. This sign informs waterway users that fixed cameras are used to monitor vessel operations in the area.
2. The sign may only be erected at locations approved by Maritime Safety Queensland within the Department of Transport and Main Roads. Contact the nearest regional office of Maritime Safety Queensland for the approval process.
3. The sign should only be erected where contraventions of marine safety or marine pollution requirements are known compliance issues.
4. The sign may be erected near public marine facilities.
5. For optional camera sign refer to MS1023\_2.

**Colour Legend**

- Retroreflective blue
- Retroreflective white

<b>Queensland Government</b>			<b>INFORMATION SIGN</b> <b>"VESSEL MONITORING CAMERAS IN USE"</b>		
Maritime Safety Queensland			Approved as a Marine Sign		<b>MS1023_1</b> Page 1 of 2
Designed TV 07/13	Checked PK 07/13	Scale Not to Scale	General Manager Maritime Safety Queensland		
			A <span style="border: 1px solid black; display: inline-block; width: 15px; height: 15px; vertical-align: middle;"></span>		

81

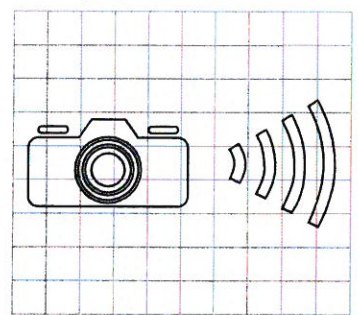
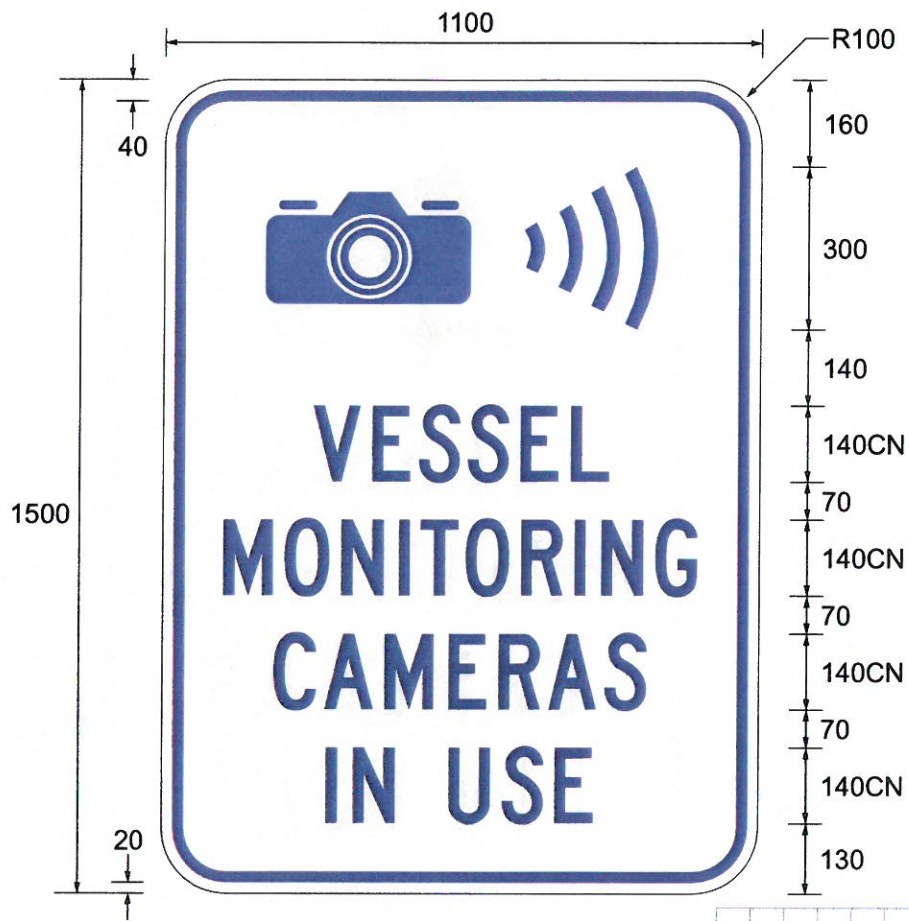

**Notes**

1. This sign informs waterway users that cameras are used to monitor vessel operations in the area.
2. The sign may only be erected at locations approved by Maritime Safety Queensland within the Department of Transport and Main Roads. Contact the nearest regional office of Maritime Safety Queensland for the approval process.
3. The sign should only be erected where contraventions of speed limits and other prohibitions or restrictions are known compliance issues.
4. The sign may be erected near public boat ramps.
5. For optional camera sign refer to MS1023\_1.

**Colour Legend**

- Retroreflective blue
- Retroreflective white



**Queensland Government**

**INFORMATION SIGN**  
"VESSEL MONITORING CAMERAS IN USE"

Maritime Safety Queensland

Approved as a Marine Sign

General Manager  
Maritime Safety Queensland

01/02/14  
Date

**MS1023\_2**

Page 2 of 2

Designed  
TV 07/13

Checked  
PK 07/13

Scale  
Not to Scale

A				
---	--	--	--	--

This page has been intentionally left blank

